

**THE ERWIN BOARD OF COMMISSIONERS
FEBRUARY 2024 REGULAR WORKSHOP
MONDAY, FEBRUARY 26, 2024 @ 6:00 P.M.
ERWIN MUNICIPAL BUILDING BOARDROOM**

AGENDA

- 1. MEETING CALLED TO ORDER**
 - A. Invocation
 - B. Pledge of Allegiance

- 2. AGENDA ADJUSTMENTS /APPROVAL OF AGENDA**

- 3. SPECIAL PRESENTATION: HARNETT REGIONAL WATER- GLENN MCFADDEN (Page 2)**

- 4. NEW BUSINESS**
 - A. Stormwater Issue - Butler Drive (Page 4)
 - B. West K Street (Page 6)
 - C. Town Engineer Updates (Page 12)
 - D. Multimodal Transportation Grant (Page 18)
 - E. Al Woodall Park State Grant (Page 29)
 - F. Police Body Camera Grant (Page 32)
 - G. FAMPO Update (Page 37)
 - H. Schedule Budget Workshop (Page 38)
 - I. ZT-2024-001 (Page 39)
 - J. ZT-2024-002 (Page 61)
 - K. Golf Course R-15 Permitted Use Text Amendment (Page 84)
 - L. R.O.W. Maintenance Text Amendment (Page 85)
 - M. Close Bayles Street Extension (Page 88)
 - N. Upcoming Events (Page 94)

- 5. CLOSED SESSION**
 - A. Pursuant to General Statute 143-318.11(a) (6) for the Purpose of Discussing Personnel
 - B. Pursuant to General Statute 143-318.11(a) (3) for the Purpose of Preserving the Attorney-Client Privilege

- 6. GOVERNING COMMENTS**

- 7. ADJOURNMENT**

ERWIN BOARD OF COMMISSIONERS
REGULAR WORKSHOP MINUTES
FEBRUARY 26, 2024
ERWIN, NORTH CAROLINA

The Board of Commissioners for the Town of Erwin with Mayor Randy Baker presiding held its Regular Workshop in the Erwin Municipal Building Board Room on Monday, February 26, 2024, at 6:00 P.M. in Erwin, North Carolina.

Board Members present were: Mayor Randy Baker, Mayor Pro Tem Ricky Blackmon, and Commissioners Charles Byrd, Timothy Marbell, Alvester McKoy, and David Nelson.

The Board Member absent was: Commissioner William Turnage

Town Manager Snow Bowden, Town Clerk Lauren Evans, Finance Officer Katelan Blount, Town Planner Dylan Eure, Town Attorney Tim Morris, and Town Engineer Bill Dreitzler were present.

Also in attendance were Harnett County Manager Brent Trout, Harnett County Board Chairman William Morris, and Harnett County Vice-Chairman Brooks Matthews.

Mayor Baker called the meeting to order at 6:00 P.M.

Town Attorney Tim Morris led the Pledge of Allegiance.

Commissioner McKoy gave the invocation.

AGENDA ADJUSTMENT/APPROVAL OF AGENDA

Commissioner Blackmon made a motion to approve the agenda as presented and was seconded by Commissioner Byrd. **The Board voted unanimously.**

SPECIAL PRESENTATION: HARNETT REGIONAL WATER- GLENN MCFADDEN

Glenn McFadden, Assistant Director for Harnett Regional Water, came forward and addressed the Board. He discussed a potential project to improve the water quality in downtown Erwin. He presented the Board with a potential drawing for the project and provided the Board with pictures of a similar project completed in two areas in the Town of Lillington. The biggest issue he wanted to address was the water not moving as it used to in the old cast iron lines, causing a decrease in water quality. Going through led and copper, they must look at the issues with types of buildings and anything before 1983.

Commissioner Marbell arrived at 6:06 PM.

Mr. McFadden continued explaining that Harnett Regional Water was looking at placing new water meters at the front of all the stores downtown but that was not fair to the Building Owners

MINUTES CONTINUED FROM FEBRUARY 26, 2024

because their plumbing came in from the back. Harnett Regional Water wanted to place holes to connect to the original waterlines and would either reimburse the Building Owners or find a grant to fund the project.

Mayor Baker asked Mr. McFadden to elaborate on the planned connectivity from the front to the back of the buildings.

Mr. McFadden stated the lines would go through the buildings, possibly through the crawl space if the building had one. Harnett Regional Water would work with each individual building owner, not the business owners, and hire a plumber to make that connection.

Mayor Baker stated a concern that needed to be addressed was that this project was not a quick fix and he wanted to know what Harnett Regional Water proposed to minimize the adverse effect on our Downtown businesses.

Mr. McFadden stated the plumber could come in and do multiple connections a day. A proposed combination of evenings and Sundays could also be worked into the project proposal. They would do their best to never close the entire road down at one time.

Commissioner Blackmon stated he had received the most complaints about the downtime for our businesses. He clarified that Harnett Regional Water planned to go into each business, remove the main tap, and run the lines straight to the sidewalk.

Mr. McFadden stated Harnett Regional Water would contract with an engineer, have a survey completed of the area, then take the plans to each of the property owners and then they will begin moving everything to the front of the buildings, put the waterlines in the edge of the concrete, and finally connect the lines to wherever it ties into the back of the buildings.

Commissioner Blackmon asked if each line or tap could be sized according to occupancy and tailored to each specific business.

Mr. McFadden stated that was correct. They would meet with each building owner and ensure they have the capacity each business needs. He wanted to make sure the Town Board was comfortable with the project before reaching out to the Building Owners. They were still in the initial stages and would come back to the Town Board with an official plan after speaking with the building owners.

NEW BUSINESS**Stormwater Issue- Butler Drive**

Sean McBride of 937 Butler Drive. He stated he had lived in Erwin for 35 years. He purchased his property Alvis Oldham and nothing had been done to the property in 120 years. The growth of vegetation came right to the edge of the road. It was his understanding that the Town of Erwin owned 15 feet back from the edge and 30 feet from the center. He and his wife had spent many days cleaning out the vegetation from their ditches. He began having conversations with Town Manager Snow Bowden regarding the issues with Stormwater runoff in 2019. He paid \$2.50 a month for Stormwater and did not have any Stormwater runoff. His neighbor's crawl space

Erwin Board of Commissioners

REQUEST FOR CONSIDERATION

To: The Honorable Mayor and Board of Commissioners

From: Snow Bowden, Town Manager

Date: February 26, 2024

Subject: Harnett Regional Water Presentation

Harnett Regional Water Assistant Director Glenn McFadden will be at our workshop meeting to discuss a potential project to improve the water quality in downtown Erwin. He has spoken to me personally a few times about this plan and I feel like this plan is in the best interest of the Town of Erwin. Mr. McFadden is taking the time out of his day to be here to explain why this is the best option for the property owners in downtown Erwin.

If you have any questions or concerns, please bring them up during this discussion. Harnett Regional Water can include certain requirements in the bid form for the project that should hopefully address any concerns, as an example:

1. Resurface any damaged areas of East H Street and not just patch holes:
2. Require the work closing the road be done at nighttime to avoid any business closures:
3. Assist business owners with the costs of relocating their plumbing to tie into the new set-up

I truly do feel like this is the best solution for the property owners in downtown Erwin. Of course, there will be some growing pains with this project but ultimately once it is completed it should be a major improvement for our downtown.

- MAINS TO REMAIN IN SERVICE
- MAINS TO BE ABANDONED
- PROPOSED SERVICE CONNECTIONS
- EXISTING GAS MAIN
- EXISTING SEWER MAIN

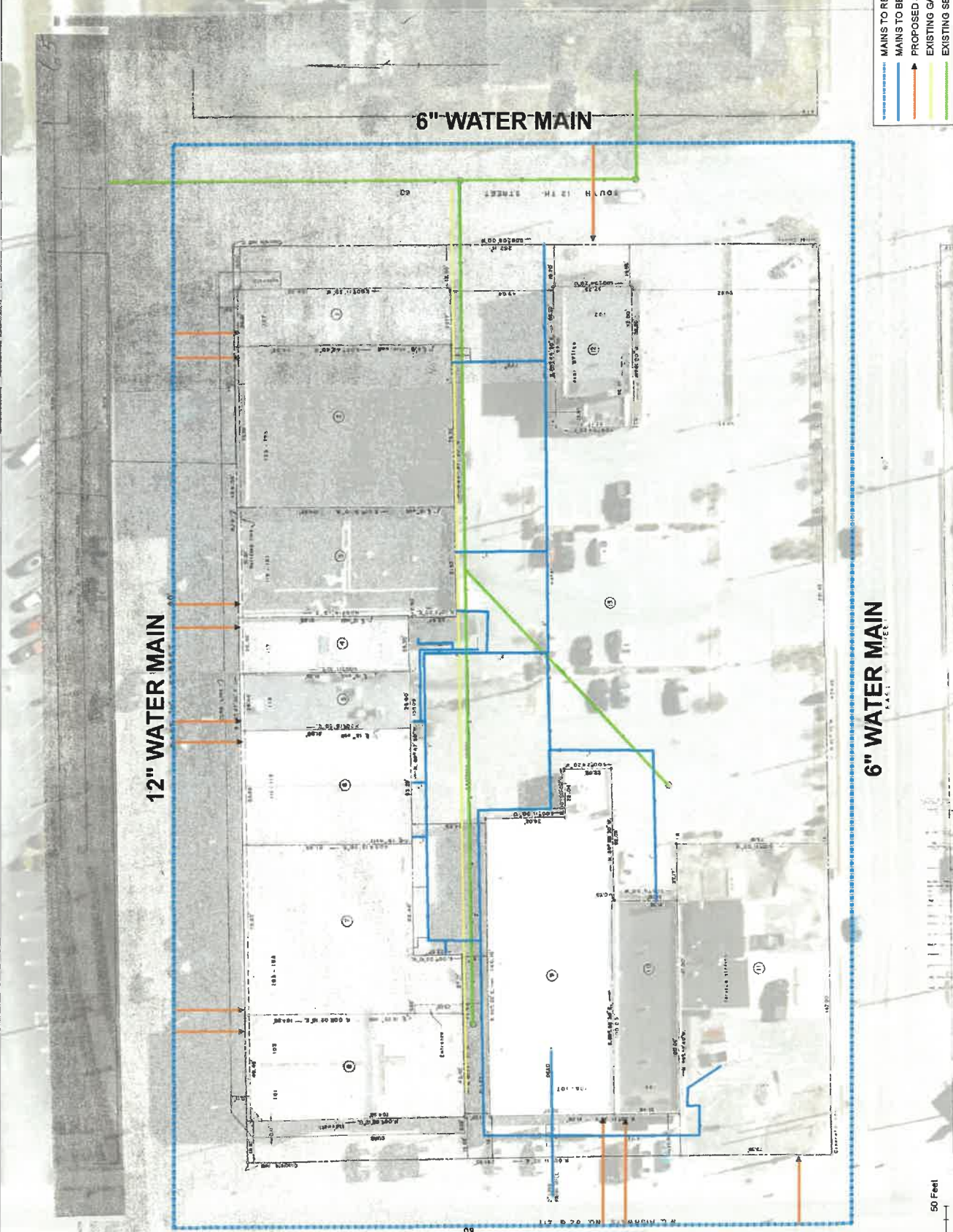

0 12.5 25 50 Feet

MINUTES CONTINUED FROM FEBRUARY 26, 2024

routinely fills up with water and spent thousands of dollars to have the underside of his house waterproofed. Mr. McBride stated he did all he could to be a good neighbor, he recently spent approximately \$5,600 cutting a ditch from the edge of Butler Drive to the backside of his property, measuring 475 feet long. The work was completed by a grading contractor he hired. Last April the water came close to half of an inch from going over the slab on grade foundations of his neighbors' homes. He questioned whether the homes across the street from his house should have ever been built due to the area being a floodplain. He asked the Board to consider reimbursing him for the money he spent due to the inactivity of the Town on Butler Drive. When the road that the Mill put in was paved, they put a culvert under the road which dumped water on the previous property owner.

West K Street

Town Engineer Bill Dreitzler stated we had an opportunity to request funding for West K Street. He reached out to our consultant to ask for a quote on replacing the culvert versus the tunneling option. He asked the Board for direction so that we could finalize our plans. Based on the price difference, he recommended the tunneling option because it would be less intrusive and better protect Harnett Regional Water's waterlines and Dunn's transmission lines.

Commissioner Blackmon stated he agreed with Town Engineer Bill Dreitzler's recommendation of the tunneling option.

Mayor Baker asked if the downstream effects had been addressed.

Town Engineer Bill Dreitzler stated it had been addressed; he performed a hydraulic analysis.

Mayor Baker informed the Board that we had contacted Representative Penny to request grant funding to address the issue on West K Street.

The consensus of the Board was to move forward with obtaining plans for the tunneling option.

Town Engineer Bill Dreitzler stated he would reach back out to the consultant to finalize the plans and have an updated project schedule sent to Town Manager Snow Bowden to keep the Board informed of the timeline.

Town Engineer Updates

Town Engineer Bill Dreitzler stated Town Manager Snow Bowden asked him to provide the Board with some updates on ongoing projects. He received the plans for the additional parking at Al Woodall Park. The bid form take-off was completed, all he had left to do was to put together a little bit of the front end and he hoped to have that completed by the end of the week. He would have recommendations to the Board by our March Workshop. He also updated the Board on the bids for the resurfacing project. Bids were due on March 19th for resurfacing a portion of N 16th Street, N 11th Street (East H Street to near East L Street), and Duke Street. The bid forms were

Erwin Board of Commissioners

REQUEST FOR CONSIDERATION

To: The Honorable Mayor and Board of Commissioners

From: Snow Bowden, Town Manager

Date: February 26, 2024

Subject: Stormwater Issue- Butler Drive

Sean McBride lives at 937 Butler Drive and he is here tonight to speak to the Town Board in regards to a stormwater problem on his property that he had to fix. He also wants to raise some concerns about maintenance in the town right-of-way. There is a pipe that goes underneath Butler Drive that puts a lot of stormwater on Mr. McBride's property. There are stormwater issues in this section of Town that Mr. McBride wants to make everyone aware of as well.

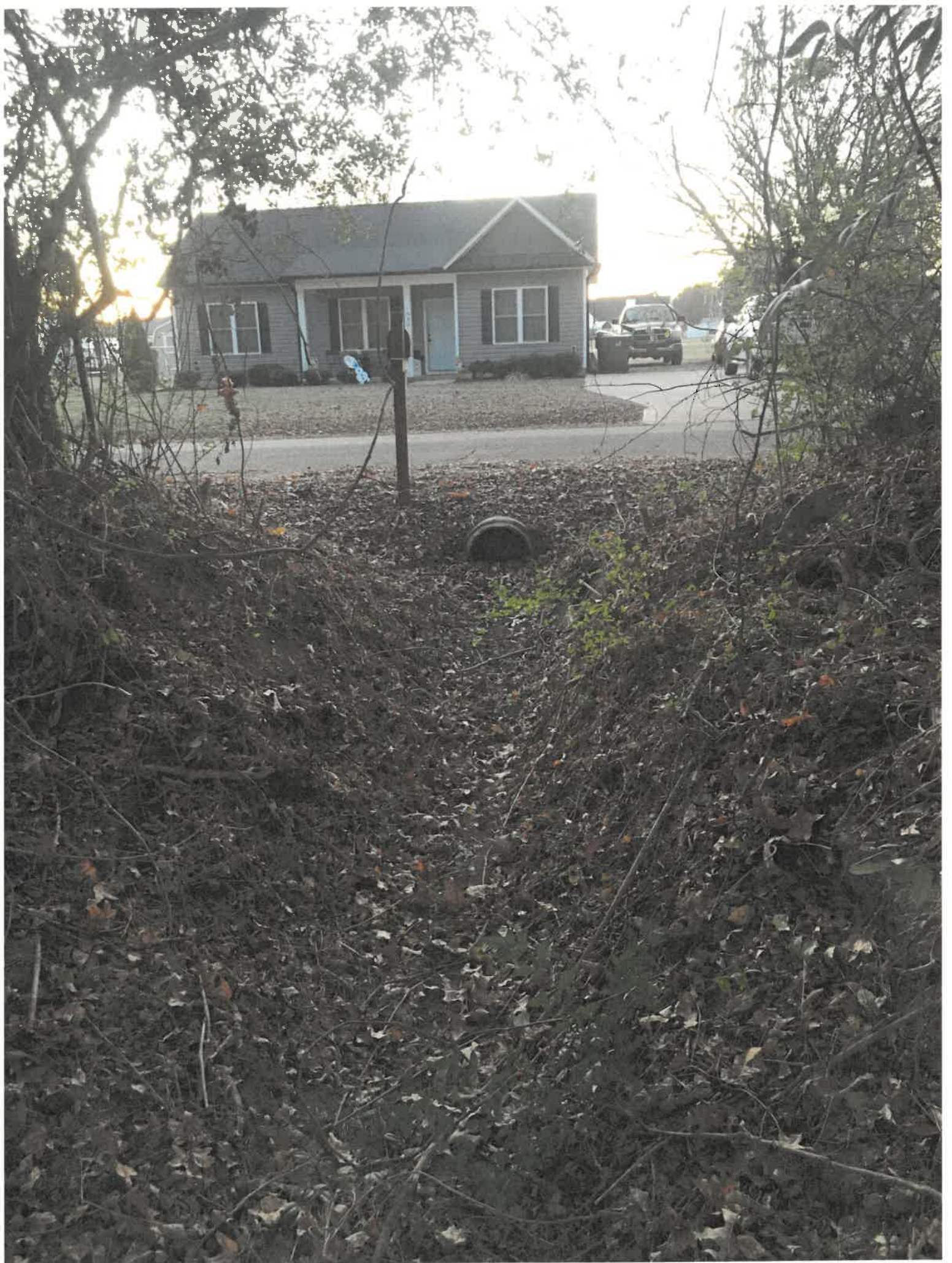

Erwin Board of Commissioners

REQUEST FOR CONSIDERATION

To: The Honorable Mayor and Board of Commissioners

From: Snow Bowden, Town Manager

Date: February 26, 2024

Subject: West K Street

Our Town Engineer Bill Dreitzler has an update on West K Street. We have two proposed fixes for West K Street.

- Open-Cut estimate- \$1,151,311.56
- Bore (Tunneling)- \$1,209,845.31

Our Town Engineer Bill Dreitzler recommends the tunneling option as the best option. I have sent a request for funds to complete this project to our N.C. House Rep. Howard Penny.

Project Summary – January 18, 2024 West K Street Culvert Replacement

A site meeting was held on December 5, 2023 to discuss existing utilities within the project area. Those attending the meeting included:

Gordon Rose	Gradient (Engineer)
Richard Ringler	GEL Solutions (Surveyor)
Bill Dreitzler	Town Engineer, Town of Erwin
Snow Bowden	Town Manager, Town of Erwin
Billy Cottle	Assistant Public Utilities Director, City of Dunn (Plus 2 others with the Utilities Department)
Kenny Keel	Harnett Regional Water

It was determined there are two (2) water lines along West K Street, not just one as shown on Harnett County GIS. The line on the south side of the road is an 8-inch diameter water main owned and maintained by Harnett Regional Water.

A brief site visit was made by Gordon Rose on January 13, 2024. It was noted that erosion has continued progressing southward and has reached the pavement on the north side of West K Street. It was also noted that the 24-inch water main has become more exposed (see photo below).



There is also further evidence of the potential for more erosion as evidenced by the extensive cracks noted in the soil around the eroded area (see photo below).



The City of Dunn will be undertaking measures to protect their pipe, beginning January 22, 2024. Once these protective measures are installed, they will need to be field located and included in the plan set for the culvert replacement.

Construction Drawings:

Progress continues on preparation of construction drawings for the culvert replacement. Below is a view of the current plan and profile sheet for the proposed replacement.

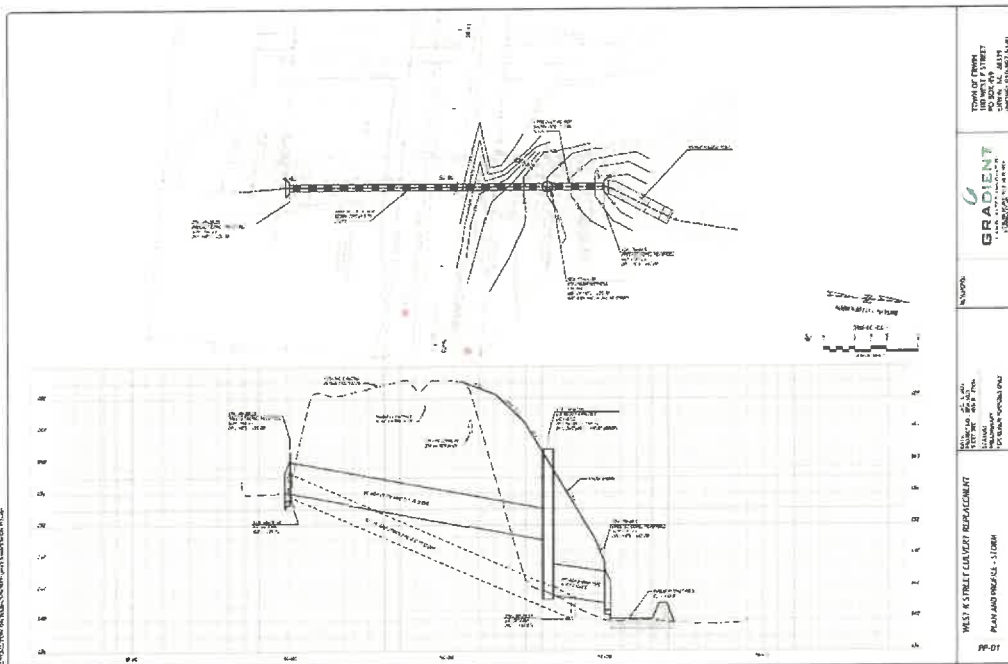

TOWN OF ERWIN
 100 WEST F STREET
 PO BOX 459
 ERWIN, NC 28339
 PHONE: 910-897-5140



REVISIONS:

DATE: NOV. 8, 2023
 PROJECT NO.: RW-1001
 SHEET SIZE: ANS I D - 24x34
 STATUS: PRELIMINARY
 FOR REVIEW PURPOSES ONLY

WEST K STREET CULVERT REPLACEMENT
 PLAN AND PROFILE - STORM

10-PP-44

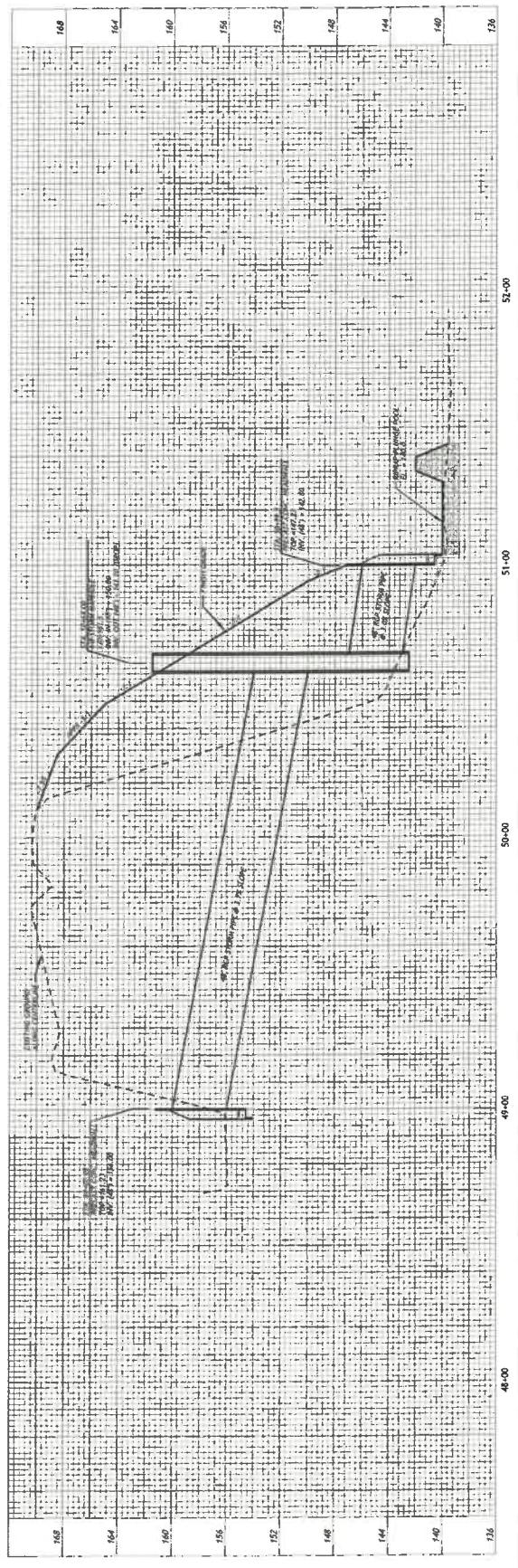
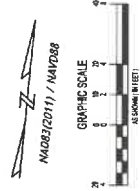
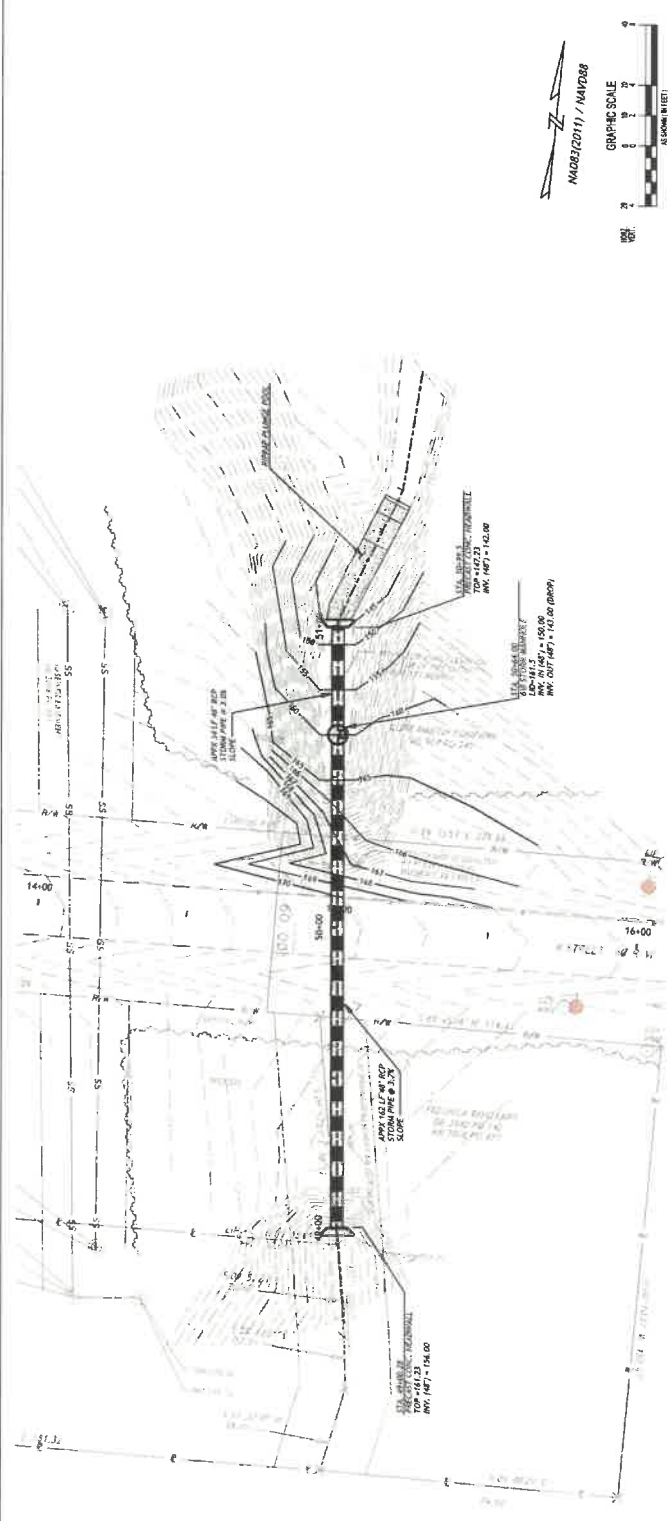

Z:\WORK\ERWIN\1001\DWG\SCHEMATIC\1001-PP-44.dwg

Project:	West K Street Culvert Replacement		Project No.:		
Owner:	Town of Erwin, NC				
Engineer:	Gradient, PLLC				
Option	<i>Option 1: Open Cut & Replace</i>				
Base Bid					
Item No.	Item Description	Unit	Estimated Quantity	Unit Price	Extended Amount
Items in Base Bid (excluding Allowances) per Section 01 29 01 "Measurement and Basis for Payment"					
A-01	MOBILIZATION (2.5%)	LS	1	2.5%	21,419.75
A-02	EROSION CONTROL (2.5%)	LS	1	2.5%	21,419.75
A-03	TRAFFIC CONTROL (2.5%)	LS	1	2.5%	21,419.75
A-04	CLEARING AND GRUBBING	AC	1.0	25,000.00	25,000.00
A-05	UNCLASSIFIED EXCAVATION	CY	6,500.0	55.00	357,500.00
A-06	UNDERCUT EXCAVATION	CY	100	60.00	6,000.00
A-07	SELECT BORROW MATERIAL	CY	2,000	60.00	120,000.00
A-08	TEMPORARY STREAM DIVERSION	LS	1	25,000.00	25,000.00
A-09	INSTALL, MAINTAIN, AND REMOVE TEMPORARY BARRIER FENCE	LF	500	22.00	11,000.00
A-10	REMOVE & DISPOSE OF EXISTING ASPHALT PAVEMENT	SY	300	20.00	6,000.00
A-11	PLANT MIX BITUMINOUS CONCRETE SURFACE COURSE, TYPE S9.5C - COF	SY	300	15.00	4,500.00
B-01	REMOVE AND DISPOSE OF EXISTING 36" CMP	LF	180	58.00	10,440.00
B-02	48" RCP, CLASS III	LF	200	620.00	124,000.00
B-03	INSTALL 6' DIAMETER SW MANHOLE, 18'-20' DEPTH	EA	1	20,000.00	20,000.00
B-04	48" RCP CONCRETE HEADWALL	EA	2	9,000.00	18,000.00
B-05	RIP RAP, CLASS 1 WITH FILTER FABRIC	TN	62	175.00	10,850.00
B-06	SEEDING AND MULCHING, AC	AC	1.0	5,500.00	5,500.00
C-01	REMOVE EXISTING 8" WATER MAIN	LF	100	10.00	1,000.00
C-02	FURNISH & INSTALL NEW 8" RJ DUCTILE IRON WATER MAIN	LF	100	350.00	35,000.00
C-03	FURNISH & INSTALL NEW 8" RJ GATE VALVE w/ VALVE BOX	EA	2	5,000.00	10,000.00
C-04	CONNECTING TO EXISTING WATER MAIN	EA	2	2,500.00	5,000.00
C-05	STERILIZATION & TESTING	LF	1,200	10.00	12,000.00
C-06	TEMPORARY SUPPORT FOR 24-INCH MAIN DURING CONSTRUCTION	LS	1	50,000.00	50,000.00
					-
					-
					-
					-
					-
Total Base Bid Items Amount (Sum of Extended Amounts for each Base Bid Line Item)					\$ 921,049.25
				10%	\$ 92,104.93
				15%	\$ 138,157.39
Total Estimate					\$ 1,151,311.56

Project:	West K Street Culvert Replacement	Project No.:
Owner:	Town of Erwin, NC	
Engineer:	Gradient, PLLC	
Option	<i>Option 2: Bore</i>	

Base Bid

Item No.	Item Description	Unit	Estimated Quantity	Unit Price	Extended Amount
Items in Base Bid (excluding Allowances) per Section 01 29 01 "Measurement and Basis for Payment"					
A-01	MOBILIZATION (2.5%)	LS	1	2.5%	22,508.75
A-02	EROSION CONTROL (2.5%)	LS	1	2.5%	22,508.75
A-03	TRAFFIC CONTROL (2.5%)	LS	1	2.5%	22,508.75
A-04	CLEARING AND GRUBBING	AC	1.0	25,000.00	25,000.00
A-05	UNCLASSIFIED EXCAVATION	CY	500.0	55.00	27,500.00
A-06	UNDERCUT EXCAVATION	CY	100	60.00	6,000.00
A-07	SELECT BORROW MATERIAL	CY	2,000	60.00	120,000.00
A-08	TEMPORARY STREAM DIVERSION	LS	1	15,000.00	15,000.00
A-09	INSTALL, MAINTAIN, AND REMOVE TEMPORARY BARRIER FENCE	LF	500	22.00	11,000.00
A-10	REMOVE & DISPOSE OF EXISTING ASPHALT PAVEMENT	SY	100	20.00	2,000.00
A-11	PLANT MIX BITUMINOUS CONCRETE SURFACE COURSE, TYPE S9.5C - COF	SY	100	15.00	1,500.00
B-01	GROUT FILL EXISTING 36" CMP	LF	180	250.00	45,000.00
B-02	BORE 48" RCP, CLASS III	LF	200	3,000.00	600,000.00
B-03	INSTALL 6' DIAMETER SW MANHOLE, 8'-10' DEPTH	EA	2	6,500.00	13,000.00
B-04	48" RCP CONCRETE HEADWALL	EA	2	9,000.00	18,000.00
B-05	RIP RAP, CLASS 1 WITH FILTER FABRIC	TN	62	175.00	10,850.00
B-06	SEEDING AND MULCHING, AC	AC	1.0	5,500.00	5,500.00
C-01	REMOVE EXISTING 8" WATER MAIN	LF	-	10.00	-
C-02	FURNISH & INSTALL NEW 8" RJ DUCTILE IRON WATER MAIN	LF	-	350.00	-
C-03	FURNISH & INSTALL NEW 8" RJ GATE VALVE w/ VALVE BOX	EA	-	5,000.00	-
C-04	CONNECTING TO EXISTING WATER MAIN	EA	-	2,500.00	-
C-05	STERILIZATION & TESTING	LF	-	10.00	-
C-06	TEMPORARY SUPPORT FOR 24-INCH MAIN DURING CONSTRUCTION	LS	-	50,000.00	-
					-
					-
					-
					-
					-
					-
					-
					-
Total Base Bid Items Amount (Sum of Extended Amounts for each Base Bid Line Item)					\$ 967,876.25
		Contingency		10%	\$ 96,787.63
		Construction Period Services		15%	\$ 145,181.44
Total Estimate					\$ 1,209,845.31

MINUTES CONTINUED FROM FEBRUARY 26, 2024

on the website for anyone who wanted to bid on the project but he did send the bid forms directly to Paterson, Barnhill, Hyland's, and Mr. Johnson.

Multimodal Transportation Grant

Town Manager Snow Bowden stated this grant opportunity was awarded and administered by NCDOT. We would be applying for a multimodal bicycle and pedestrian plan and we already had a Resolution of endorsement from our RPO. Town Staff was hopeful that if we can obtain this grant, we would meet our #3 goal in our 2023 Land Use Plan which stated "Enhance existing infrastructure and services while providing safe and efficient multi-modal transportation."

The consensus of the Board was to place this item under Consent on the agenda for our Regularly Scheduled Meeting in March.

Commissioner Blackmon and Commissioner Byrd left at 6:54 PM.

Al Woodall Park State Grant

Town Manager Snow Bowden stated that the Town would be receiving a \$50,000 grant from the State of North Carolina. The funds were being funneled through Harnett County. Town Staff was requesting permission from the Board to use these funds to resurface the two tennis courts at Al Woodall Park and turn one tennis court into two pickleball courts. The estimated cost for this project would be \$65,000-\$70,000.

The consensus of the Board was to place this item under Consent on the agenda for our Regularly Scheduled Meeting in March.

Police Bodycams

Town Manager Snow Bowden informed the Board that Police Chief Johnson found this grant that was available for rural law enforcement agencies and Town Staff was requesting the approval of the Board to apply. It would require an "in-kind" match from the Town of Erwin. He received a quote for new body cameras and if we received this grant, it would cover the first three years of payments.

The consensus of the Board was to place this item under Consent on the agenda for our Regularly Scheduled Meeting in March.

FAMPO Updates

Town Manager Snow Bowden stated he wanted to make the Board aware that he would be attending a meeting on Monday, March 4th in regards to the Town of Erwin becoming a member of FAMPO. He was unsure of the timeline but he thought we would have already received an MOU but as soon as he received a timeline, he would pass that information on to the Board.

Erwin Board of Commissioners

REQUEST FOR CONSIDERATION

To: The Honorable Mayor and Board of Commissioners

From: Snow Bowden, Town Manager

Date: February 26, 2024

Subject: Town Engineer Updates

Our Town Engineer Bill Dreitzler has some other updates for you that include:

- We are going to be putting out bids next week for the parking lot addition at Al Woodall Park.
- Bids are due on March 19th, 2024 at 2PM for the following streets to be resurfaced:
 - A portion of North 16th Street
 - North 11th Street (East H Street to near East L Street)
 - Duke Street

As a reminder we typically work with whichever company wins the bid to identify and fix some of our major potholes.

NOTES

1. CONDITIONS SHOWN ON THIS PLAN ARE CURRENT CONDITIONS AT THE DATE OF CONSTRUCTION AND ARE NOT TO BE USED AS A BASIS FOR CONSTRUCTION TO VERIFY ALL PROPERTY CORNERS AND DIMENSIONS PRIOR TO COMMENCING CONSTRUCTION ACTIVITIES.

DRAFTING AND DESIGN SERVICES, INC.
 6715 CAMDONTON ROAD
 WYOMING, WY 82001
 (307) 476-2799 phone
 dsd@draftingdesign.com

**ERWIN PARK
 PARKING LOT ADDITION
 310 S 16th STREET
 ERWIN, NORTH CAROLINA**

SITE EXISTING CONDITIONS/DEMOLITION PLAN

REVISIONS

Scale	1"=50'	Drawn by	MMK
Sheet	C2 of 5	Designed by	MMK
Project Number	202448	Reviewed by	MTB
Date	JAN 2024		



ALL ELEVATIONS SHOWN
 IN THIS DRAWING ARE
 ELEVATIONS OF GROUND

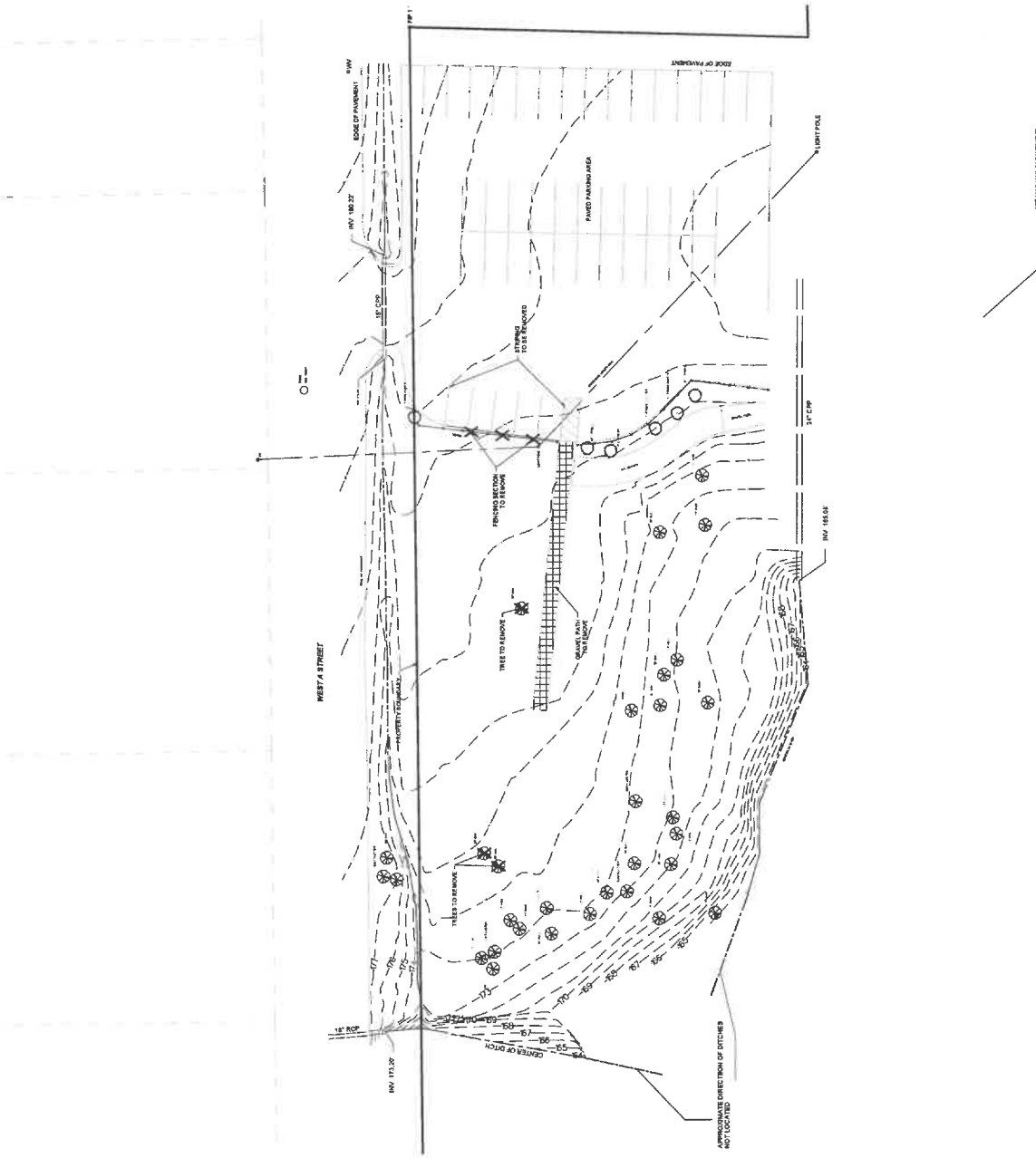

D RAFTING AND DESIGN SERVICES, INC.

1375 CLAYTON ROAD
 SAFFOLD, NORTH CAROLINA 27330
 919-496-8799 phone
 info@raftingdesign.com

**ERWIN PARK
 PARKING LOT ADDITION
 810 S 16TH STREET
 ERWIN, NORTH CAROLINA**

SITE STAKING PLAN

PRELIMINARY NOT FOR CONSTRUCTION	
Scale: 1"=40'	Drawn by: BMR
Sheet: C3 5	Designed by: BMR
Project Number: 2023-02	Reviewed by: BMR
Date: JAN 2024	

NOTES

1. ALL DIMENSIONS ARE TO EDGE OF PAVEMENT UNLESS OTHERWISE NOTED.
2. ALL AREAS CONSIDERED AS ADA ARE TO MEET ADA STANDARDS.
3. CONTRACTOR TO VERIFY FINAL DIMENSIONS AND LOCATION PRIOR TO CONSTRUCTION.
4. CHECK FOR ALL UTILITY LOCATIONS AND DEPT. RECORDS IN BOTH TYPE MATERIAL AND SOILS.

SITE DATA

EXISTING UTILITIES:
 10" WATER MAIN
 12" GAS MAIN
 12" SANITARY SEWER
 12" ELECTRIC MAIN

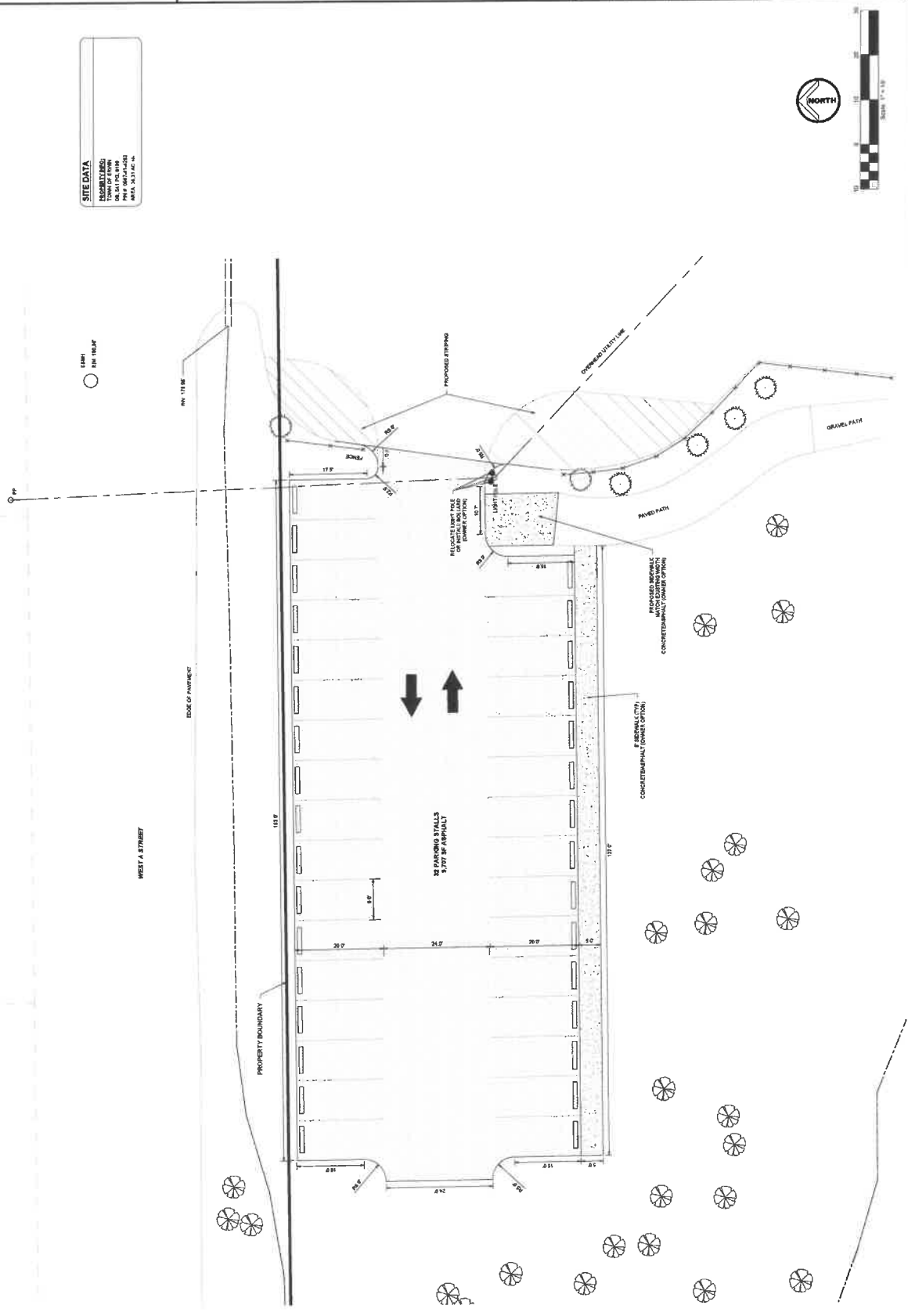

NOTES

1. LIMIT OF DISTURBANCE (L.O.D.) SITE DISTURBANCE IS LESS THAN 10 THEREFORE MONICROED
2. LAND DISTURBANCE PERMIT REQUIRED
3. EXISTING UTILITIES TO BE PROTECTED AND MAINTAINED
4. CONSTRUCTION ACTIVITIES TO BE LIMITED TO THE DISTURBANCE PERMIT AREA
5. PROPOSED CONTOUR MUST BE SHOWN AT 1' HORIZONTALS

CONSTRUCTION REQUIREMENTS

1. INSTALL TEMPORARY SILT FENCE IN LOCATION AS SHOWN ON PLANS AND SET FENCE
2. UTILITIES AS NECESSARY IN ANY LOW POINTS IN SILE
3. PROTECT EXISTING UTILITIES FROM DAMAGE
4. PROTECT EXISTING UTILITIES FROM DAMAGE
5. SLOPE PROTECTION SHALL BE INSTALLED WITHIN LIMITS OF DISTURBANCE
6. SLOPE PROTECTION SHALL BE INSTALLED WITHIN LIMITS OF DISTURBANCE
7. SLOPE PROTECTION SHALL BE INSTALLED WITHIN LIMITS OF DISTURBANCE
8. SLOPE PROTECTION SHALL BE INSTALLED WITHIN LIMITS OF DISTURBANCE
9. SLOPE PROTECTION SHALL BE INSTALLED WITHIN LIMITS OF DISTURBANCE
10. SLOPE PROTECTION SHALL BE INSTALLED WITHIN LIMITS OF DISTURBANCE

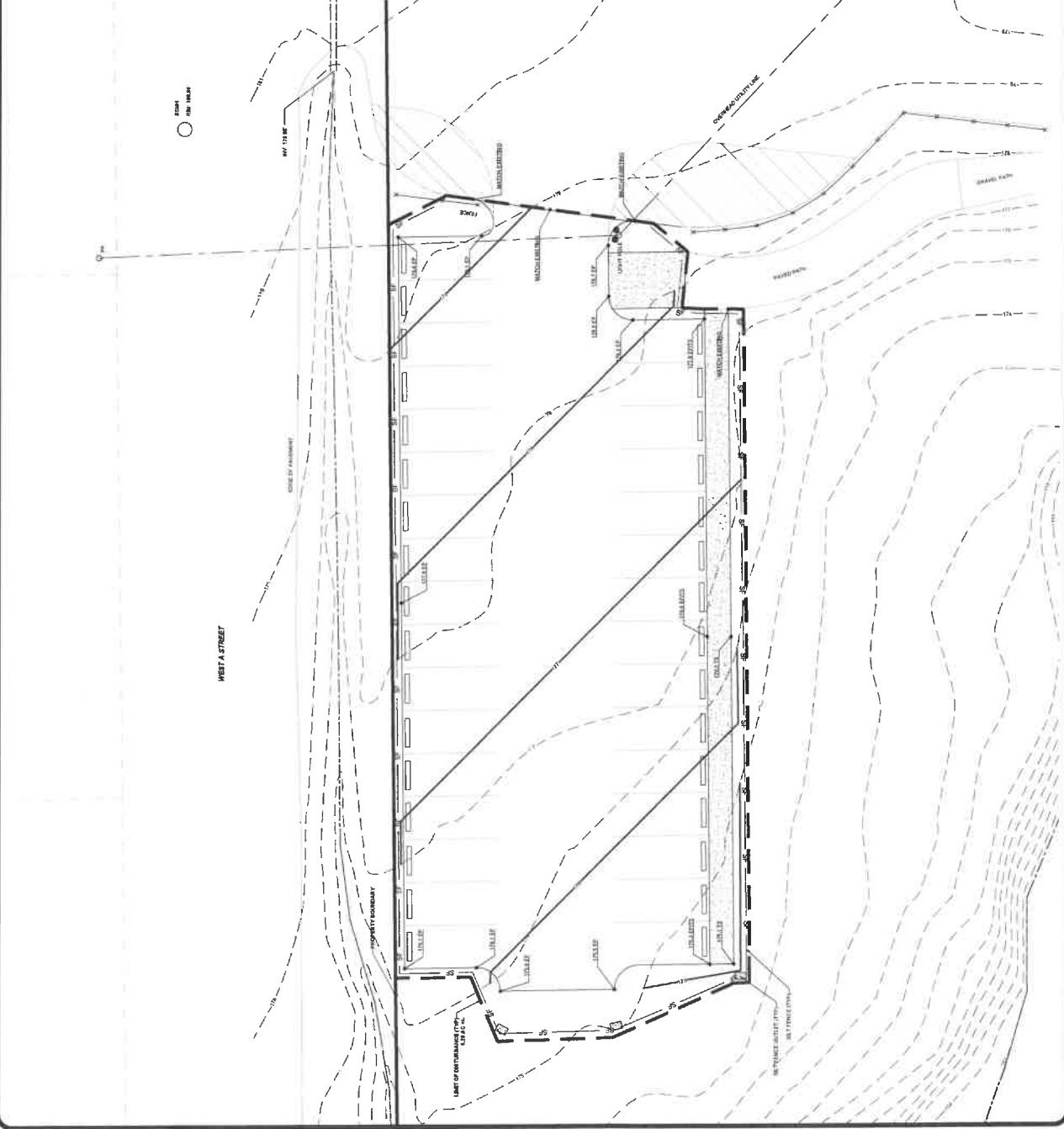

EROSION CONTROL LEGEND

- SILT FENCE
- SILT FENCE OUTLET
- LIMIT OF DISTURBANCE



**ERWIN PARK
PARKING LOT ADDITION
810 S 16TH STREET
ERWIN, NORTH CAROLINA**

NETWORKS

**PRELIMINARY
NOT FOR CONSTRUCTION**

Scale:	1"=40'	Drawn by:	MDK
Sheet:		Designed by:	MDK
Project No.:	C4 - 5	Reviewed by:	MTB
Project Name:	ERWIN PARK	Date:	JAN 2004

DRAFTING AND DESIGN SERVICES, INC.
 1775 CALVERTON ROAD
 SAUCE SPED, NORTH CAROLINA 27329
 (919) 494-8779 Phone
 (919) 494-8779 Fax
 WWW.DRAFTINGANDDESIGN.COM

**ERWIN PARK
 PARKING LOT ADDITION
 810 S 16TH STREET
 ERWIN, NORTH CAROLINA
 CONSTRUCTION DETAILS**

REVISIONS

**PRELIMINARY
 NOT FOR CONSTRUCTION**

Scale	NTS	Drawn by	MOK
Sheet		Designed by	MOK
Project Number	C5 of 5	Reviewed by	MTB
Sheet	202040	Date	JAN 2004

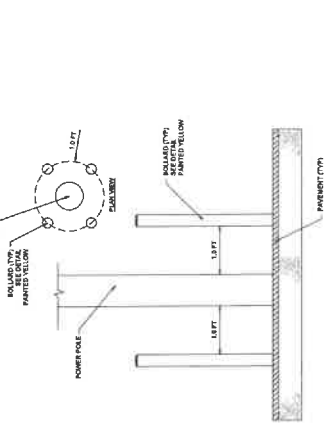

POWER POLE BOLLARD PLACEMENT DETAIL
 NTS

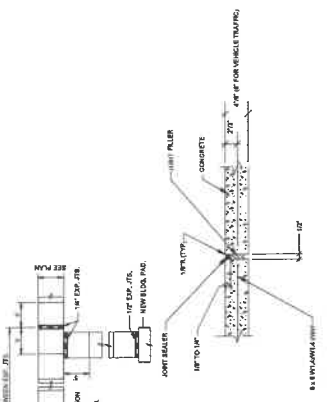

SIDEWALK
 NTS

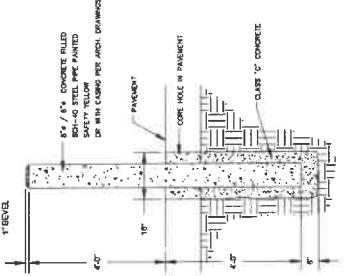

BOLLARD
 NTS

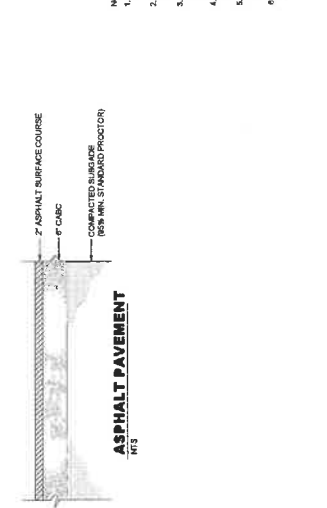

ASPHALT PAVEMENT
 NTS

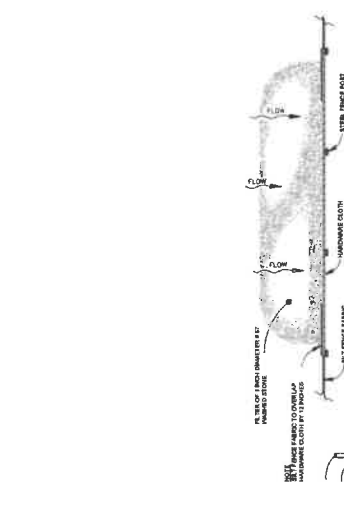

SILT FENCE OUTLET
 NTS

NOTES:

1. ALL BOLLARDS SHALL BE 4" THICK UNLESS OTHERWISE NOTED.
2. CONSTRUCTION JOISTS SHALL BE SPACED AT 16" ON CENTER.
3. CONSTRUCTION JOISTS SHALL BE FORMED, TRUED AND EGGED WITH 1/4" RADIUS OR MAY BE SAWNOT T-OVER.
4. AND TOWARD PAVED AREAS.
5. 1/2" DIA. JT. MATERIAL REQUIRED WHERE CONC. JOINTS MEET AT CORNERS OF BUILDINGS.
6. A LAYER OF 1/4" BLDG. FELT IS REQUIRED BETWEEN WALK AND ADJACENT PARALLELING CONC. CURB.

NOTES:

1. THE BOLLARD SHALL BE 4" THICK UNLESS OTHERWISE NOTED.
2. THE BOLLARD SHALL BE 18" HIGH UNLESS OTHERWISE NOTED.
3. THE BOLLARD SHALL BE 1.5" DIA. UNLESS OTHERWISE NOTED.
4. THE BOLLARD SHALL BE 18" DIA. UNLESS OTHERWISE NOTED.
5. THE BOLLARD SHALL BE 18" DIA. UNLESS OTHERWISE NOTED.
6. THE BOLLARD SHALL BE 18" DIA. UNLESS OTHERWISE NOTED.



FRONT VIEW



SIDE VIEW

Grade	Slope Length (ft)	Maximum Area (ft ²)
2 to 7%	75	7,500
8 to 12%	50	5,000
13 to 20%	30	3,000
> 20%	15	1,500

Table 8.2.2. Maximum Slope Lengths for Various Grades and Slopes

Table 8.2.2. Maximum Slope Lengths for Various Grades and Slopes. This table provides the maximum slope length for various grades and slopes. The maximum slope length is determined by the grade and the slope length. The maximum slope length is determined by the grade and the slope length.

Installation Specifications:

1. The silt fence shall be installed in a trench that is 18" deep and 18" wide.
2. The silt fence shall be installed in a trench that is 18" deep and 18" wide.
3. The silt fence shall be installed in a trench that is 18" deep and 18" wide.
4. The silt fence shall be installed in a trench that is 18" deep and 18" wide.
5. The silt fence shall be installed in a trench that is 18" deep and 18" wide.
6. The silt fence shall be installed in a trench that is 18" deep and 18" wide.

Construction Materials:

The silt fence shall be constructed of 4" thick concrete. The silt fence shall be constructed of 4" thick concrete. The silt fence shall be constructed of 4" thick concrete.

Maintenance:

The silt fence shall be maintained in good condition. The silt fence shall be maintained in good condition. The silt fence shall be maintained in good condition.

Notes:

The silt fence shall be installed in a trench that is 18" deep and 18" wide. The silt fence shall be installed in a trench that is 18" deep and 18" wide.

Notes:

The silt fence shall be installed in a trench that is 18" deep and 18" wide. The silt fence shall be installed in a trench that is 18" deep and 18" wide.

Notes:

The silt fence shall be installed in a trench that is 18" deep and 18" wide. The silt fence shall be installed in a trench that is 18" deep and 18" wide.

Notes:

The silt fence shall be installed in a trench that is 18" deep and 18" wide. The silt fence shall be installed in a trench that is 18" deep and 18" wide.

Notes:

The silt fence shall be installed in a trench that is 18" deep and 18" wide. The silt fence shall be installed in a trench that is 18" deep and 18" wide.

Notes:

The silt fence shall be installed in a trench that is 18" deep and 18" wide. The silt fence shall be installed in a trench that is 18" deep and 18" wide.

Notes:

The silt fence shall be installed in a trench that is 18" deep and 18" wide. The silt fence shall be installed in a trench that is 18" deep and 18" wide.

Notes:

The silt fence shall be installed in a trench that is 18" deep and 18" wide. The silt fence shall be installed in a trench that is 18" deep and 18" wide.

Notes:

The silt fence shall be installed in a trench that is 18" deep and 18" wide. The silt fence shall be installed in a trench that is 18" deep and 18" wide.

Notes:

The silt fence shall be installed in a trench that is 18" deep and 18" wide. The silt fence shall be installed in a trench that is 18" deep and 18" wide.

Erwin Board of Commissioners

REQUEST FOR CONSIDERATION

To: The Honorable Mayor and Board of Commissioners

From: Snow Bowden, Town Manager

Date: February 26, 2024

Subject: Multimodal Transportation Grant

Town Staff wishes to apply for a multimodal planning program grant. The grant is awarded and administered by the North Carolina Department of Transportation. The grant would require a 10% match by the Town of Erwin if we are awarded the grant. The typical costs for a plan like this varies from \$35,000 to \$45,000. On the high end of this we would be expected to contribute \$4,500 if the plan costs \$45,000. By applying for this grant we are trying to start the process in reaching "Goal #3" in our 2023 Land Use Plan (attached).

We would be applying for a bicycle and pedestrian project acceleration study and not a full multimodal network plan due to the fact that we do not have mass transit in the area yet. I do not think the HARTS (Harnett County transit system) would fit in well with this type of plan.

Attachments:

- Proposed resolution
- FAQ's
- Land Use Plan goal #3

Frequently Asked Questions (FAQ's)

What is the difference in the traditional comprehensive bicycle and pedestrian plan and the project acceleration plans? The traditional bicycle and pedestrian plans take a comprehensive approach evaluating an entire community and providing varied project, policy, program and administration recommendations and implementation strategies. The project acceleration plans are envisioned as a more focused document concentrating on the identification of priority projects that are implementable for smaller communities with more limited resources. The plan development process will be of a much shorter timeframe (around six months) and the final plan document will be of a more minimal length. ([Content Standards for Project Acceleration Plans.](#))

NOTE: A community can apply for only one type of plan in an individual grant cycle.

Can county or regional government agencies apply for funding?

Counties with populations of less than 100,000 may apply on behalf of incorporated communities and/or unincorporated areas within their jurisdiction. County governments with populations greater than 100,000 and regional governments are not eligible to apply, nor are colleges/universities or other non-municipal entities.

Can a municipality that already has a plan apply for funding?

Municipalities (and counties with populations of less than 100,000) who currently have a comprehensive bicycle and/or pedestrian plan at least five (5) years old may apply for funding to update their plan. Municipalities may have plans that target only off-road projects, as in a greenway master plan, or just on-road improvements as part of an existing transportation plan and are therefore not viewed as a comprehensive planning document for this planning grant program. Such plans typically do not address elements that are a part of comprehensive planning document, such as, policy, education, enforcement, maintenance, and land use/development issues. To understand what is included in a multimodal network plan, a comprehensive pedestrian and/or bicycle plan, or project acceleration plan, see the "Content Standards" documents provided on the respective plan webpages found on the sidebar: <https://connect.ncdot.gov/municipalities/PlanningGrants/IMD-Multimodal-Planning-Program/Pages/default.aspx>

If a proposal was submitted in a previous grant cycle, can the same proposal be resubmitted?

The application is slightly modified every year to clarify/improve both the application process and the review process. Therefore, a new application form must be submitted to be eligible for consideration each year. All municipalities are encouraged to re-apply. Those municipalities that received funding in previous years may apply for the type of plan, bicycle or pedestrian, for which they did not receive funding in the past.

Can the plan be a project/corridor plan, or focus on a sub-area of a municipality or specific construction project?

Funding is only intended to support the development of a comprehensive bicycle, pedestrian or joint bicycle and pedestrian transportation plan for the entire municipality. However, for the project acceleration plans, there will be a more project identification/implementation emphasis that may focus

attention to certain corridors and areas of a community.

Can the funding be used to develop a bicycle or pedestrian element of other municipal planning efforts?

Any plan developed with these funds must be comprehensive in nature and be a stand-alone bicycle or pedestrian plan. While NCDOT encourages the inclusion of bicycle and pedestrian elements in local comprehensive plans, transportation plans, land use plans, recreation plans, greenway and open space plans, etc., requests for funding to develop such elements are not within the scope of this grant.

Can in-kind services be used for a local match?

In-kind services cannot be used for local participation. The local match must be a cash contribution.

Can other non-municipal funds be used for the local cash match?

Other NCDOT state or federal funds provided to a municipality cannot be used as a local cash match. Funds secured from other state or federal agencies and organizations or businesses may be used for the local match.

Can Powell Bill funds be used for a local match?

No, Powell Bill funds may not be used toward the local match – see [here](#). However, funds secured from state agencies other than NCDOT may be used for a local match.

How much does a plan cost to develop?

Average costs associated with the development of plans vary greatly depending on the size of the municipality and the complexity of issues to be addressed in the plan. Average costs associated with a plan update are 50%-75% of the cost of a standard plan. Cost may vary depending on the extent of the update; however, communities should budget for the maximum estimate. A range of estimated costs for plans developed by consultants is shown below. The cost of all plans funded through this program shall be within these established ranges. After awardee notification, the specific cost of the plan will be determined through discussions between NCDOT and the municipality (or county) and through contract negotiations between NCDOT/municipality/county and the selected consultant.

Population	Estimated Consultant Costs
Less than 10,000 (Project Acceleration Plan)	\$35,000 to \$45,000
Less than 10,000	\$50,000 to \$60,000
10,000 to 25,000	\$50,000 to \$65,000
25,000 to 50,000	\$55,000 to \$70,000
50,000 to 100,000	\$65,000 to \$100,000
Over 100,000	\$85,000 to \$190,000

Note: Average costs associated with a plan update are 50%-75% of the cost of a standard plan. Cost may vary depending on the extent of the update; however, communities should budget for the maximum estimate.

What percent does my town pay?

NCDOT planning grant funds will be provided on a sliding scale, based on municipal (or county) population, as shown in the table below. Neither in-kind services nor other state or federal funds from

NCDOT can be used for local participation.

Municipal Population	DOT Participation	Local Participation
Less than 10,000	90%	10%
10,000 to 25,000	80%	20%
25,000 to 50,000	70%	30%
50,000 to 100,000	60%	40%
Over 100,000	50%	50%

When will selected municipalities/counties receive the funding?

It is anticipated that municipalities/counties will be notified of the planning grant award in June 2023. A municipality/county selected for funding must execute a legal agreement with the NCDOT prior to receiving funding authorization. This agreement will outline the responsibilities of each party, the terms and the deliverables.

As described in the *Multimodal Planning Grant Overview* document, NCDOT will utilize prequalified on-call firms to prepare the plans.

The municipality/county will submit a lump sum of their matching funds for this project with the signed agreement. NCDOT will then administer all payments to the consultant preparing the plan. The planning process will begin once (a) the municipal agreement is executed, and local match is received and (b) NCDOT has assigned a consultant to the project and negotiated plan cost.

What is the time frame for executing a municipal agreement between NCDOT and a funded municipality/county?

Once a municipality/county is notified of award, NCDOT will generate a municipal agreement and forward it to the municipality/county for execution. The municipality/county shall submit an executed contract within three months of award notification.

How long will the municipality/county have to complete the plan?

It is anticipated that selected consultants will have twelve months (around 6 to 8 months for the Project Acceleration plans *or* approximately 6 to 9 months for plan updates) from the date of receipt of an NCDOT written Notice to Proceed to complete the plan. Final timelines will be determined during creation of agreements and finalization of consultant contracts.

How will proposals be selected for funding?

Integrated Mobility Division (IMD) staff will conduct a preliminary review of all applications for completeness and general appropriateness. An Awards Committee will review all proposals that pass the initial screening and will forward their funding recommendations to the NCDOT Board of Transportation for final approval. The Awards Committee will include IMD staff and individuals with professional experience in developing, administering, and / or implementing bicycle plans and pedestrian plans. These individuals will represent municipalities of varying sizes, MPO's and RPO's, COG's and other appropriate agencies and organizations. It is anticipated that the Board of Transportation will approve selected municipalities/counties in June 2023.

What are the selection criteria?

The NCDOT Planning Grant Awards Committee will review each proposal and evaluate it based on the stated vision, goals and needs of the municipality/county; comprehensiveness of scope; understanding of issues and opportunities; level of local commitment; and, feasibility of successful plan completion. For a comprehensive list of criteria, see the "Selection Criteria" section of the *Multimodal Planning Program Overview* document:

(<https://connect.ncdot.gov/municipalities/PlanningGrants/Documents/Multimodal%20Planning%20Grant%20Program%20Overview.pdf>).

What type of assistance is available to local staff preparing an application?

Staff from the NCDOT Integrated Mobility Division (IMD) will be available to answer questions and provide guidance. (Bryan Lopez at balopez@ncdot.gov, 919-707-2606). MPO and RPO planning staff may also be able to provide helpful information or staff assistance. In addition, content standards, a list of past awardees, completed plans, and links to Web sites that provide general information on bicycle and pedestrian planning may be found on the Multimodal Planning Program webpage:

(<https://connect.ncdot.gov/municipalities/PlanningGrants/IMD-Multimodal-Planning-Program/Pages/default.aspx>).

Is the funding provided on an "all or nothing" basis?

Yes. Applications for funding for a comprehensive municipal bicycle or pedestrian plan from a municipality/county that can provide the necessary level and type of matching funds are the only type of proposals that will be considered.

What does a bicycle plan or pedestrian plan look like?

A list of plans may be found on the Multimodal Planning Program page

(<https://connect.ncdot.gov/municipalities/PlanningGrants/Pages/Grant-Recipients-and-Completed-Plans.aspx>).

Can the funds be used for construction of sidewalks, greenway trails or other capital improvements projects?

These funds are made available for the development of comprehensive bicycle and/or pedestrian transportation plans only. Proposals detailing specific construction projects are not eligible for consideration.

Is there a "live person" available who can answer my questions?

Yes, you can contact: Bryan Lopez (919) 707-2606 / balopez@ncdot.gov

Transportation, Infrastructure, and Services



Goal 3: Enhance existing infrastructure and services while providing safe and efficient multi-modal transportation.

TIS 1: Prioritize pedestrian improvements.

- 1.1:** Refine plans for priority pedestrian corridors and develop cost estimates for priority projects.
- 1.2:** Earmark funds annually toward sidewalk repairs, connections and crossing improvements.
- 1.3:** Research and apply for a NCDOT Bicycle and Pedestrian Planning Grant.
 - ◆ This grant could be utilized to create a system-wide plan, refine recommendations for pedestrian priorities, options and cost estimates.
- 1.4:** Convert Denim Drive from 4 lanes to 2-3 lanes with improved pedestrian crossings and on-street parking.
 - ◆ Denim Drive carries only a fraction of the traffic it once did (3,800 cars a day west of Old Post Road and 7,400 cars per day east of Old Post Road). Even with significant increases in traffic a four lane road is unnecessary and the design of the roadway invites speeding. A streetscape improvement project could include reallocation of pavement width to on-street parking, enhanced crosswalks, wider sidewalks and/or additional landscaping.

TIS 2: Maintain and enhance the Dunn-Erwin Trail.

- ◆ The Dunn-Erwin Trail is a 5 mile trail of crushed stone that traverses an old rail bed between Downtown Erwin and the west side of Dunn. This trail is an incredible amenity for residents of Erwin and surrounding communities. Maintaining the trail and improving access points, furnishings and encouraging usage is a priority for the town.
- 2.1:** Inventory facilities along the trail and develop a formalized maintenance plan in cooperation with the Dunn-Erwin Rail Trail Committee and Public Works.

- 2.2:** Consider trail updates that may include benches, additional parking and access points, lighting at key locations, safety call boxes, signage, art installations and/or landscaping.

TIS 3: Plan for necessary maintenance of local roads.

- 3.1:** Conduct regular road condition assessments.
- 3.2:** Create annual reports and a 3-5 year capital improvement plan (CIP) to factor in needed expenditures related to road maintenance.
- 3.3:** Coordinate with NCDOT to improve maintenance of the right-of-way along US 421.



TIS 4: Coordinate with NCDOT, and regional transportation planning organizations on highway access, improved street connectivity and long-term roadway needs.

- ◆ The Town of Erwin is currently part of the Mid-Carolina Rural Planning Organization (MCRPO). Increased coordination with the Capital Area Metropolitan Planning Organization (CAMPO) and the Fayetteville Area Metropolitan Planning Organization (FAMPO) on regional transportation issues will be necessary in the future.

TIS 5: Maintain and enhance stormwater drainage infrastructure.

- 5.1:** Prioritize the maintenance of town-owned drainage infrastructure.
- 5.2:** Encourage property owners to maintain ditches on private property.
- 5.3:** Continue pursuing grants for updates to stormwater infrastructure in areas with frequent flooding and/or inadequately sized pipes or culverts.

TIS 6: Work with Harnett Regional Water to maintain and enhance water and sewer infrastructure.

- 6.1:** Coordinate with Harnett Regional Water to improve access to water and sewer service along the US 421 corridor.

Town of Erwin Land Use Plan

Pedestrian Improvements Priorities Map

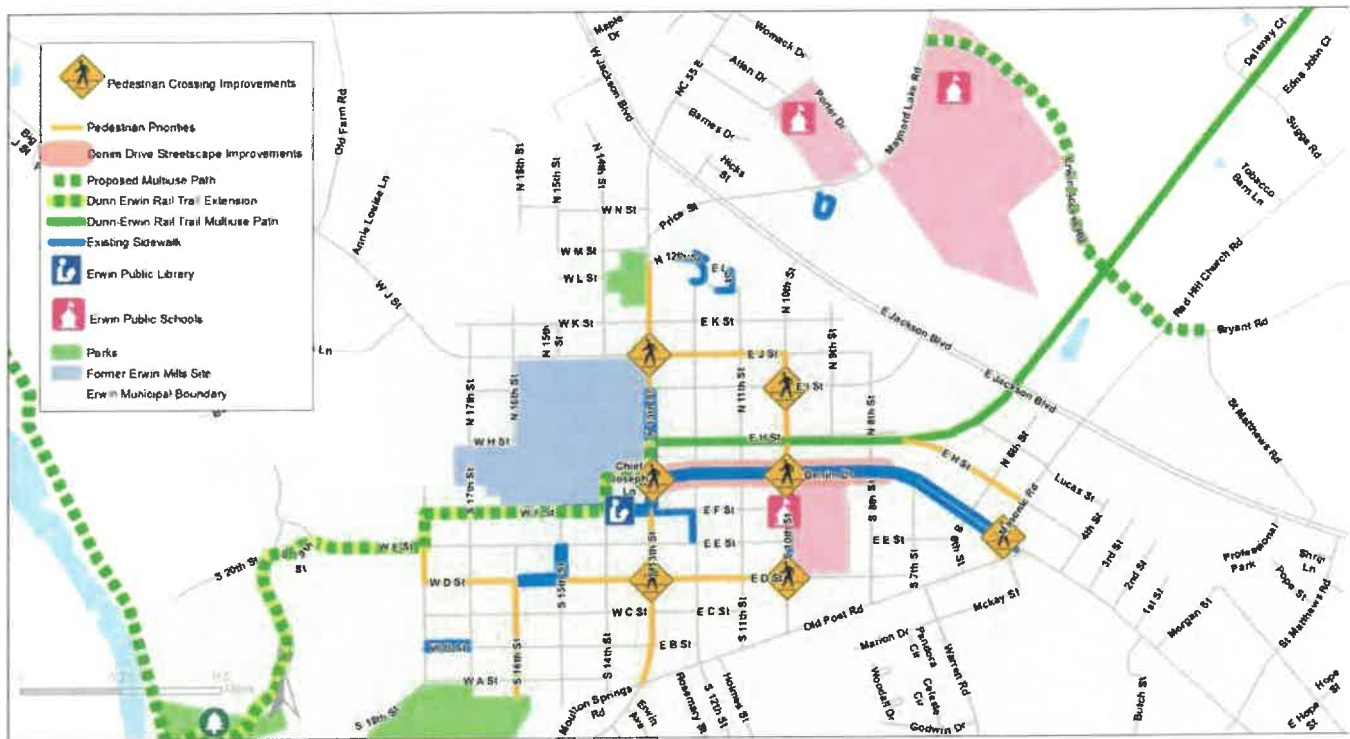

Crossing Improvements	Location
Denim Drive and 10th Street	Repaint crosswalk, add pedestrian crossing signal at light for crossing across <u>Denim Drive</u> .
Denim Drive and 13th Street	Repaint crosswalk, add pedestrian crossing signal at light for crossing across <u>Denim Drive</u> .
Denim Drive and Masonic Rd	Add painted crosswalk and crossing signal across Denim Drive and <u>Masonic Road</u> .
East D Street and 10th Street	Add painted crosswalk across S 10th Street as well as School <u>Crossing signage</u> .
East J Street and S 10th Street	Add painted crosswalk across East J Street.
J Street and North 13th Street	Add painted crosswalk across N 13th Street
D Street and South 13th Street	Add painted crosswalk across S 13th Street

Priority Corridors	To/From
North 10th Street	Denim Drive to East J Street
D Street	18th Street to 10th Street and on 18th Street from West D Street to West E <u>Street</u>
13th Street	N 12th Street to East I Street
13th Street	F Street to Old Post Road
East J Street	N 13th Street to N 10th Street
16th Street	Woodall Municipal Park to West D Street
E H Street and Masonic Road	Dunn-Erwin Rail Trail to Denim Drive
Improve Dunn-Erwin Rail Trail <u>Extension</u>	Sidewalk, paved trail or enhanced signage from 13th Street to Cape Fear River <u>Trail</u>
Erwin Access Road	Multi-use path from Maynard Lake Road to St Matthew Road

Denim Drive Streetscape Concept

Denim Drive (Existing)

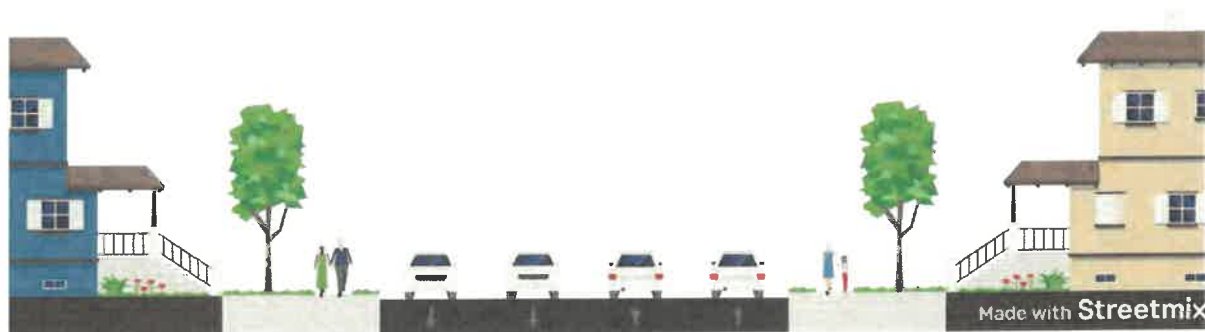

Denim Drive (Future)

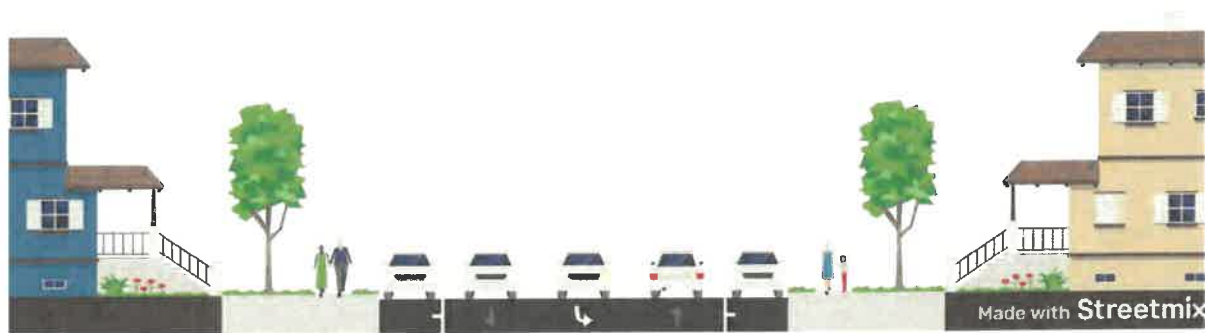

The cross-sections above shows how Denim Drive could be converted from a 4 lane facility to a two-lane road with a center turn lane and on-street parallel parking. This would increase pedestrian safety and comfort while still providing adequate room for vehicular traffic.



**Mid-Carolina Council of Governments
Rural Transportation Planning Organization**

Mr. Mike Rulan
Director, Mid-Carolina RPO
(919) 824-0451
6205 Raeford Road
Fayetteville, NC 28304
mcrpo.com

RURAL TRANSPORTATION ADVISORY COMMITTEE

**Mardy Jones
Chairman**

**Glenn Adams
Vice-Chair**

**RESOLUTION ENDORSING THE TOWN OF ERWIN'S
APPLICATION FOR THE NCDOT MULTIMODAL PLANNING
TRANSPORTATION GRANT**

February 2024

WHEREAS, the North Carolina Department of Transportation (NCDOT) has established a Multimodal Transportation Planning Grant which provides funding to projects that result in comprehensive local bicycle and pedestrian plans, while also considering for the Harnett Area Rural Transit System; and

WHEREAS, the Town of Erwin has expressed a desire to apply for funding through the NCDOT Multimodal Transportation Planning Grant Initiative; and

WHEREAS, in order to be selected, the Town of Erwin must agree to take place in NCDOT's Multimodal Implementation Program requiring Erwin to provide updates on the implementation of the plan; and

WHEREAS, the Mid Carolina Rural Planning Organization Transportation Advisor Committee considers it to be in the best interest of residents within the Town of Erwin and the surrounding community for the Town to apply for consideration of the Multimodal Transportation Planning Grant Initiative;

THEREFORE, BE IT RESOLVED that the Mid Carolina Rural Planning Organization Transportation Advisory Committee endorses and fully supports the Town of Erwin application to be a recipient of the NCDOT Multimodal Transportation Planning Grant.

ADPOTED this 15th day of February, 2024

Signature TAC Chair

Signature Mid Carolina RPO Director



TOWN OF ERWIN

P.O. Box 459 • Erwin, NC 28339
Ph: 910-897-5140 • Fax: 910-897-5543
www.erwin-nc.org

RESOLUTION ENDORSING THE TOWN OF ERWIN'S APPLICATION FOR THE NCDOT MULTIMODAL PLANNING TRANSPORTATION GRANT

2023-2024—002

Mayor
Randy L. Baker
Mayor Pro Tem
Ricky W. Blackmon
Commissioners
Alvester L. McKoy
Timothy D. Marbell
Charles L. Byrd
David L. Nelson
William R. Turnage

WHEREAS, the North Carolina Department of Transportation (NCDOT) has established a Multimodal Transportation Planning Grant which provides funding to projects that will result in comprehensive local bicycle and pedestrian plans while taking consideration for the Harnett Area Rural Transit System; and

WHEREAS, the Town of Erwin has expressed a desire to apply for funding through the NCDOT Multimodal Transportation Planning Grant Initiative; and

WHEREAS, in order to be selected the Town of Erwin must agree to take place in NCDOT's Multimodal Implementation Program requiring Erwin to provide updates on the implementation of the plan; and

WHEREAS, the Erwin Board of Commissioners believes that it is in the best interest of the residents within the Town of Erwin to apply to be considered as a possible recipient of the Multimodal Transportation Planning Grant Initiative;

THEREFORE, BE IT RESOLVED that the Board of Commissioners from the Town of Erwin endorses the application to be a recipient of the NCDOT Multimodal Transportation Planning Grant.

ADOPTED, this the 7th day of March, 2024.

Randy Baker

Mayor

ATTEST:

Lauren Evans, NCCMC

Town Clerk

Erwin Board of Commissioners

REQUEST FOR CONSIDERATION

To: The Honorable Mayor and Board of Commissioners

From: Snow Bowden, Town Manager

Date: February 26, 2024

Subject: Al Woodall Park State Grant

The Town of Erwin is receiving a \$50,000 grant from the State of North Carolina, thanks to our Senator Jim Burgin. Just like the grant last year, the funds are being funneled through Harnett County, and they must serve a public purpose. One of the goals in our 2023 Land Use Plan is to continue to maintain and improve our existing parks. One request that I hear all the time is that we need pickleball courts at Al Woodall Park. We have two tennis courts at Al Woodall Park that are in serious need of repair. We would like to resurface both of these courts and turn one of the tennis courts into two separate pickleball courts. Town Staff believes that this is one of the best and quickest projects we can get going with these funds (similar to the parking lot improvements last year).

If you are not familiar with pickleball, it is the fastest-growing sport in America at the moment. I feel pretty confident in saying that these courts would be used if we move forward with this project. We would like to keep one of the tennis courts because people still use them.

Town Staff believes that we could do this project for \$65-70K.

Attachments:

- 2023 Land Use Plan goals
- What is pickleball- [How to Play Pickleball \(usapickleball.org\)](https://usapickleball.org)

Parks and Natural Resources



Goal 4: Provide equitable access to parks and natural areas while continuing to increase opportunities to access the Cape Fear River and Dunn-Erwin Trail.

PNR 1: Continue to maintain and improve existing parks.

1.1: Pursue grants for improvements at Al Woodall Municipal Park.

- ◆ Priority improvements for Al Woodall Municipal Park include:
 - ◆ An additional access, parking lot and bathroom facility near Field #4
 - ◆ Pole and light upgrades
 - ◆ Resurfacing of courts and skatepark
 - ◆ Upgrade security cameras throughout park
 - ◆ Addition of shade trees and walking path connectors

1.2: Pursue grants for improvements at W.N. Porter Park including creek bank stabilization and stormwater upgrades.

PNR 2: Create a formalized public space downtown for events.

2.1: Study potential ways to formalize a public space to be used for town events.

- ◆ This could include creating a formal agreement with property owners and/or improvements to town-owned property.

PNR 3: Coordinate with Harnett County on:

- ◆ Leagues and Programming
- ◆ Improving recreational access in under served areas of the ETJ
- ◆ Development of a future nature park on the Black River
- ◆ Providing additional access points along the Cape Fear River.

PNR 4: Plan for new open space and amenities in future residential development.

4.1: Continue density bonus structure to encourage more open space reservation in subdivisions. Review and revise incentives to create quality subdivisions.

PNR 5: Study potential locations for a new neighborhood park to serve growing residential areas.



Erwin Board of Commissioners

REQUEST FOR CONSIDERATION

To: The Honorable Mayor and Board of Commissioners

From: Snow Bowden, Town Manager

Date: February 26, 2024

Subject: Police Bodycams

Chief Johnson has submitted a request for funds to purchase new body cams for our officers in the Erwin Police Department in the upcoming Fiscal Year. Both Chief Johnson and I believe it is very important for our officers to have body cams. Chief Johnson has found a grant that is available for rural law enforcement agencies that the Town of Erwin qualified for. It does require an "in-kind" match. The maximum amount that we can apply for is \$28,000. The Town would like to apply for funds of \$28,000 for this grant program. We can use town personnel administrative hours (ie. reviewing body cam footage by supervisors) towards meeting our "in-kind" match so it should not be an issue meeting this requirement. We found out about this grant a little late and the deadline to apply is Monday, March 4th. Town Staff is requesting permission to apply for this grant.

BODY 4 CAMERA QUOTE EXECUTIVE SUMMARY

Erwin Police Department

Axon Enterprise, Inc.
17800 North 85th Street
Scottsdale, AZ 85255

Main Contacts:

Nick Sinatra
(704) 336-0449
nsinatra@axon.com





Axon's Body 4 package bundles hardware, software, accessories, equipment refreshes, and warranties together to help equip your officers with the solutions they need to stay safe.

Erwin Police Department and Axon Enterprise, Inc. (Axon) will be partnering to deliver a Body Worn Camera (BWC) solution at a total 5 year cost of **\$76,533.80**. Through the department's utilization of our TAP program, as well as providing Erwin Police Department with a bundled solution, this will result in a **savings of approximately \$7,849.20** for the city over the next five-years. Our goal is to deliver predictable annual spend, and the best technology in order to reduce your agency's liability while increasing your agency's efficiency and, most importantly, safety.

The solution created for Erwin Police Department includes:

Hardware:

- ▶ (14) Axon Body 4 Cameras
- ▶ (2) 8-Bay Docking Stations for Charging and Evidence Offload
- ▶ (16) BWC Mounts

Software:

- ▶ (2) Professional Evidence.com Licenses
 - ▶ Access to Multi-Cam Playback, Redaction Studio, Device Analytics, etc.
- ▶ (12) Basic Evidence.com Licenses
 - ▶ Access to Axon Capture Mobile Application, Axon View App, Evidence.com Retention Policies, Axon Device Manager, etc.

Warranties and Equipment Refreshes:

- ▶ Technology Assurance Plan (TAP)
 - ▶ Full 5-year "No Questions Asked" Warranty on All Cameras
 - ▶ (14) of the Latest Body Worn Cameras at Year 2.5 AND Year 5

Axon Professional Services Training :

- ▶ Virtual Body Camera Starter : Virtual Setup & System Admin End User Training

Yearly Pricing Breakdown:

- ▶ Year 1: **\$15,306.76**
- ▶ Year 2 = **\$15,306.76**
- ▶ Year 3 = **\$15,306.76**
- ▶ Year 4 = **\$15,306.76**
- ▶ Year 5 = **\$15,306.76**
- ▶ Total Cost = **\$76,533.80**



Body 4 Overview



Axon Body 4 is more than just a body camera - It's your reliable partner on the field, maximizing safety and transparency with enhanced camera options, longer-lasting battery, and the ability to request support anywhere. With streamlined operation and faster charging, you'll spend less time on administrative tasks and more time on what really matters - keeping yourself and others safe. The improved security and storage options give you the confidence that your footage is secure and always within reach. Plus, the optional Flex POV module lets you capture every moment from any angle. Elevate your performance and safety with Axon Body 4.

Capture unique perspectives with the optional Flex POV module. Plug it into an Axon Body 4 camera to record from new angles, like head mounted, shoulders, or in-hand for viewing around corners or underneath vehicles. It's smaller, lighter, and more durable than the Flex 2, with an IP67 waterproof rating and no need for charging, resulting in maximum flexibility.

FEATURES & BENEFITS

FULL SHIFT CONNECTED CAMERA WITHOUT COMPROMISES

Don't let a dead battery leave you exposed. With a larger 4300 mAh battery, Axon Body 4 lasts a full shift even when using Respond real-time services.

FASTER, MORE CONVENIENT CHARGING

Get back to work quickly with the new magnetic disconnect fast charge cable, which delivers 20% charge to your device in 30 minutes.

IMPROVED SECURITY AND STORAGE

Capture footage with confidence knowing it is secured with XTS-AES 256 bit disk encryption. Plus, with an increased 128GB solid state hard drive, you can store even more footage and images.

ENHANCED IMAGING

Never miss a moment with our enhanced camera options. The 4.3 aspect ratio with a 160-degree field of view increases visibility by 39%, allowing you to capture more of the situation. Plus, our upgraded 5 MP sensor provides sharper images with more detail.



Axon TAP – Technology Assurance Plan

“The Technology Assurance Plan has been a great benefit to our agency. Being able to only go through the budget process once for the products and services needed over the next 5 years creates exponential administrative savings. The TAP program is what I call a ‘set it and forget it’ system.

Everything needed for the program is covered for the 5-year period. No hidden fees or unexpected costs. If equipment breaks or fails, the TAP program kicks into action. Replacement equipment is quickly provided in order to keep your program running smoothly.”

– Sgt. Tim White; Greenbelt

WHAT IS TAP?

The Technology Assurance Plan (TAP) is a service plan that combines warranty coverage on your Axon body cameras with automatic refresh units every 2.5 years. Minimizing the chance that an officer goes on duty without a camera. TAP includes on-site spare units, as well as an extended warranty at no additional cost through the life of the agreement. TAP not only protects your agency today — it ensures it will stay protected in the future.

WHO USES TAP?

Over 2,500 proactive agencies have used TAP as a way to maintain their body camera program in the most cost-effective way possible. TAP is quickly becoming a favorite budget-planning tool, helping agencies replace equipment without having to find extra funding to do so. It enables you to buy essential technology as an operational line item rather than as a one-off capital expenditure. TAP allows you to focus on policing and provides certainty within your budget.

WHY USE TAP?

- Free “No Questions Asked” warranty
- Automatic refresh of Axon body camera and dock units every 2.5 years
- On-site spares*
- Budget certainty

*On-site spares provided when an agency subscribes to the TAP program. Spares are limited to 1 per agency.

Additional Program Products & Features:

Evidence.com

Axon Evidence is a scalable, cloud-based system that consolidates all of your digital files, making them easy to manage, access, and share. Now you can also know your evidence is securely stored in Microsoft Azure’s Government cloud, and that any activity is captured in audit trails to ensure chain of custody and evidence authenticity.

Axon Capture

Axon Capture is a mobile application built specifically for law enforcement that allows officers to capture digital evidence right from the field. The application eliminates the need to carry multiple devices for photo, video and audio recording. Instead, it uses the capabilities of the smartphone already in your pocket and adds the security and organization needed to protect truth. You can add tags, titles or GPS coordinates to any recording before uploading the data to Evidence.com, without leaving anything on your phone.

Erwin Board of Commissioners

REQUEST FOR CONSIDERATION

To: The Honorable Mayor and Board of Commissioners

From: Snow Bowden, Town Manager

Date: February 26, 2024

Subject: FAMPO Updates

I will be attending a meeting on Monday, March 4th in regards to the Town of Erwin becoming a member of FAMPO and leaving the Mid-Carolina Rural Planning Organization. At this meeting, there will be a discussion about the new proposed Memorandum-of-Understanding (MOU) that will have to be agreed upon by all parties. They have not mentioned a timeline of when it would need to be approved yet. But it might be a quick turnaround, I am not too sure.

MINUTES CONTINUED FROM FEBRUARY 26, 2024**Schedule Budget Retreat**

The Board was provided with potential dates that work best for Town Staff to schedule our upcoming Budget Workshop. Town Manager Snow Bowden asked the Board to look at their calendars and we will plan to schedule our Budget Workshop at our Regularly Scheduled Meeting in March.

ZT-2024-001

Town Manager Snow Bowden informed the Board that we would have a Public Hearing for a rezoning request off of Hog Heaven Lane. The parcel was currently zoned R-15 and RD and the applicant was requesting to rezone the parcel entirely to RD. The Planning Board did recommend this request for approval. Town Planner Dylan Eure was present to answer any questions the Board may have.

The consensus of the Board was to move forward with holding a Public Hearing at our Regularly Scheduled Meeting in March.

ZT-2024-002

Town Manager Snow Bowden stated that Town Planner Dylan Eure had proposed a zoning map amendment which would address a handful of parcels that were split-zoned, primarily around Moulton Springs Road. The Planning Board did recommend all of these parcels be rezoned. Town Staff wanted to share this proposal with the Town Board prior to scheduling a Public Hearing. Town Planner Dylan Eure had spoken with most of the property owners and explained what we wanted to do and why. Most property owners were very understanding, one property owner did have concerns about the rezoning affecting their taxes. This was the first request of multiple that Town Staff wanted to bring before the Board to help clean up our zoning map.

Town Planner Dylan Eure stated that split-zoned lots were hard to sell or add on to so this rezoning also would help the property owners in the future.

Mayor Baker asked that Town Staff obtain information from the Harnett County Tax Department to be better prepared to answer the concerns of the property owners prior to moving forward with this rezoning request.

Golf Course R-15 Permitted Use Text Amendment

Town Planner Dylan Eure stated that the need for this amendment came to his attention when researching and looking over our zoning maps. He noticed that Chicora was within the R-15 zoning district and golf courses were not currently a permitted use in this district. He also proposed a definition of a golf course.

Erwin Board of Commissioners

REQUEST FOR CONSIDERATION

To: The Honorable Mayor and Board of Commissioners

From: Snow Bowden, Town Manager

Date: February 26, 2024

Subject: Schedule Budget Retreat

Town Staff wishes to pick a day and time to meet to discuss the proposed budget for Fiscal Year 2024-2025. We will have a lot to discuss. I have received all of the budget requests from our Department Heads. This is going to be a tough budget year due to limited funds. We have exhausted the majority of our funds from the American Rescue Plan and those funds really helped the Town the last two fiscal years with salaries, and other needs. We will have to spend the rest of those funds this year. I have listed a few days below that would work in March. If one of these days and times does not work we can always look for a day and time in April. Some of us have certain days in March when we are already tied up for mandatory training.

Potential dates:

- Thursday, March 21st
- Wednesday, March 27th
- Thursday, March 28th (the day before Good Friday FYI)

Erwin Board of Commissioners

REQUEST FOR CONSIDERATION

To: The Honorable Mayor and Board of Commissioners

From: Snow Bowden, Town Manager

Date: February 26, 2024

Subject: ZT-2024-001

The Town of Erwin has received a rezoning request for a vacant parcel located off of Hog Heaven Lane. The parcel is a vacant and does not have an address. The vacant parcel can be identified by its Harnett Count Tax PIN # 1506-15-0948.000. The parcel is currently split zoned

- R-15- 15.55 acres (53.27%)
- Rural District (RD) 13.64 acres (46.73%)

The applicant has requested that this parcel be fully rezoned to Rural District (RD). The Planning Board has recommended that his rezoning request be approved. As with any rezoning request you have to consider all of the permitted uses in the district that it would change to if the rezoning request is approved. This parcel is already partially zoned RD, the applicant seeks to use this parcel for a land use that would fall under the category of a public facilities. Public facilities are not allowed in our R-15 Zoning in District.

RD

Sec. 36-77. - Intent.

This district is established to promote low-density residential and agricultural uses. The regulations of this district are intended to protect the agricultural sections of the community from an influx of uses likely to render them undesirable for farms and future development and to ensure that residential developments dependent on private wells and septic tanks will occur at sufficiently low densities to ensure a healthful environment.

(Code 1977, § 9-4024.1)

Sec. 36-78. - Permitted principal uses and structures.

The following are permitted principal uses and structures:

(1) Single-family dwellings.

(2) Farms and agricultural uses for crop and livestock production. Note: A farm shall not be construed to include commercial poultry and swine production, cattle feed lots, and fur-bearing animals.

(3) Family care home.

(4) Religious uses, including churches and other places of worship, religious education buildings and parish houses.

(5) Municipal facilities.

(6) Manufactured Class A homes on individual lots.

(7) Customary home occupations.

(8) Equine stables (private or commercial use). Only applicable in the Planning Zone. Equine stables are not permitted inside town limits.

(9) Day care centers, day nurseries, preschools, and similar uses. Day care centers, day nurseries, preschools, and similar uses may not be located within a 300-foot radius measured from the center of the property of another day care center, day nursery, preschool, or similar use.

10) Public facilities.



TOWN OF ERWIN

P.O. Box 459 • Erwin, NC 28339
Ph: 910-897-5140 • Fax: 910-897-5543
www.erwin-nc.org

Mayor
Randy L. Baker
Mayor Pro Tem
Ricky W. Blackmon
Commissioners
Alvester L. McKoy
Timothy D. Marbell
Charles L. Byrd
David L. Nelson
William R. Turnage

3/7/2024

ZT-2024-001 Memorandum

Rezoning Description

The Town of Erwin has received a request to rezone a piece of property located by its Harnett County Tax Pin: 1506-15-0948 off of Hog Heaven Lane within the Town of Erwin's planning jurisdiction but not within the Town's corporate limits. Currently this parcel is split zoned between R-15 and RD. With R-15 occupying approximately 15.55 acres or 53.27% of the property, and RD occupying approximately 13.67 acres or 46.73% of the property. Said petition would rezone the above parcel to be entirely under RD zoning classification.

Property Description

A single vacant parcel totaling 29.19 acres located off of Hog Heaven Rd within Erwin's planning jurisdiction approximately .35 of a mile south of town limits. According to Harnett County GIS no water or sewer lines are accessible through the property. Property is within both watershed HUC8 and HUC12 which will require approval from North Carolina's Department of Environmental Quality prior to development taking place. Otherwise the property is not within a flood zone or wetland. The surrounding land uses are R-15 to the North and to the West with RD being South and East of the parcel.

Findings of Fact

The requested rezoning from being split zoned with R-15 and RD to entirely with RD classification is compatible with all of the Town of Erwin's regulatory documents. According to Erwin's 2023 Land Use Plan and Erwin's Code of Ordinances the uses defined within the RD zoning classification would best serve the above stated parcel.

Regards,

Dylan Eure
Town Planner

24-2024-001
 Planning Board - 2/19/24
 Commissioners - 3/7/24

Revised 11-2-14



Application for an Amendment To The Official Zoning Map of Erwin, NC

Staff Only: Zoning Case # 24-2024-001
 Fee: _____ Check # _____ MO _____ Cash _____
 PB Recommendation: A D A W Conditions
 BOA Date: _____ Decision: A D I A W Conditions

Print Applicant Name: DONNIE CARL HAMILTON & BECKY P HAMILTON
 Name of Legal Property Owner: DONNIE CARL HAMILTON & BECKY P HAMILTON
 Location of Property: HOG HEAVEN LN DUNN, NC 28334

Please Circle One of the Following: Less than one Acre One to 4.99 Acres Five or more Acres

Zoning change requested from R 15 to RD
 If Conditional District, note conditions:

Harnett County Tax Map PIN 1 5 0 6 - 1 5 - 0 9 4 8

Property owner(s) of area requested and address(es)
DONNIE CARL HAMILTON & BECKY P HAMILTON 687 HOG HEAVEN LN DUNN NC 28334-7146

(If more space is required, please attach to this document separately)

- Submit names and addresses of property owners immediately adjacent to the proposed rezoning area (and properties within 100 feet of proposed rezoning area) and across any streets) and identify on an area map
- Attach a metes and bounds description, deed drawing of the area involved or a reference to plats in an approved subdivision on the entire property requested for change
- This application must be filed with the Town Hall by 4:00 p.m. on the Friday which is at least 25 days before the meeting at which it is to be considered and may be withdrawn without penalty no later than 19 days prior to the public hearing

Whenever an application requesting an amendment has been acted on and denied by the Town Board, such application, or one substantially similar shall not be reconsidered sooner than one year after the previous denial.

It is understood by the undersigned that the Zoning Map, as originally adopted and as subsequently amended, is presumed by the Town to be appropriate to the property involved and that the burden of proof for a zoning amendment rests with the applicant. Applicant is encouraged to Discuss the Proposed Zoning Amendment with Affected Property Owners.

Donnie Carl Hamilton 910-984-4396
 Signature of Applicant Contact Number

687 Hog Heaven Ln., Dunn, N.C. 28334
 Mailing Address of Applicant

SREMC – Hamilton Property – Rezoning Application

Names and addresses of property owners immediately adjacent to the proposed.

(properties within 100 feet of proposed rezoning area)

1. HAMILTON DONNIE CARL & HAMILTON BECKY P
 - a. PIN: 1506-15-4599.000
 - b. Mailing Address: 687 HOG HEAVEN LN DUNN, NC 28334-7146
 - c. Physical Address: 687 HOG HEAVEN LN DUNN, NC 28334-7146

2. HAMILTON RONNIE CARL & HAMILTON DEBRA LYNN
 - a. PIN: 1506-04-8916.000
 - b. Mailing Address: 473 HOG HEAVEN LN DUNN, NC 28334
 - c. Physical Address: HOG HEAVEN LN DUNN, NC 28334

3. HAMILTON RONNIE C & HAMILTON D
 - a. PIN: 1506-15-5148.000
 - b. Mailing Address: 473 HOG HEAVEN LANE DUNN, NC 28334-0000
 - c. Physical Address: 473 HOG HEAVEN LN DUNN, NC 28334

4. HAMILTON CARL JR HEIRS
 - a. PIN: 1506-04-7058.000
 - b. Mailing Address: 2628 NC HWY 82 DUNN, NC 28334-0000
 - c. Physical Address: 221 HOG HEAVEN LN DUNN, NC 28334

5. SMITH JOHN E JR
 - a. PIN: 1506-24-3948.000
 - b. Mailing Address: 473 HOG HEAVEN LANE DUNN, NC 28334-0000
 - c. Physical Address: 473 HOG HEAVEN LN DUNN, NC 28334

6. LEWIS SHARON HAMILTON & LEWIS STEPHEN AUSTIN
 - a. PIN: 1506-35-0468.000
 - b. Mailing Address: 1057 HUDSONTOWN RD DUNN, NC 28334
 - c. Physical Address: 1116 HOG HEAVEN LN DUNN, NC 28334

7. LEE KEVIN JACOB
 - a. PIN: 1506-26-4385.000
 - b. Mailing Address: 383 HINSON RD DUNN, NC 28334-9586
 - c. Physical Address: ---- HOG HEAVEN LN NC

8. ANCHOR PROPERTIES OF RALEIGH LLC
 - a. PIN: 1506-16-8759.000
 - b. Mailing Address: 503 WRENNSTONE CT APEX, NC 27529
 - c. Physical Address: ---- HOG HEAVEN LN NC

9. HARANT FRANKIE EDWIN
 - a. PIN: 1506-16-5628.000
 - b. Mailing Address: 111 LAVENDALE LN DUNN, NC 28334-6553
 - c. Physical Address: 111 LAVENDALE LN DUNN, NC 28334

10. BAIRD LARRY W & BAIRD ROXANNE
 - a. PIN: 1506-16-0834.000
 - b. Mailing Address: 135 LAVENDALE LN DUNN, NC 28334-6553
 - c. Physical Address: 135 LAVENDALE LN DUNN, NC 28334-6553

11. JENKINS ROBERT LAWRENCE JR & JENKINS MELODY L
 - a. PIN: 1506-06-4701.000
 - b. Mailing Address: 114 LAVENDALE LN DUNN, NC 28334
 - c. Physical Address: 114 LAVENDALE LN DUNN, NC 28334

12. DAVIS DON TRUSTEE & ANTIOCH PENTECOSTAL FREE WILL
 - a. PIN: 1506-06-1569.000
 - b. Mailing Address: PO BOX 2005 DUNN, NC 28335-2005
 - c. Physical Address: 494 ANTIOCH CHURCH RD DUNN, NC 28334

13. MATTHEWS SHIRLEY B
 - a. PIN: 0596-95-4677.000
 - b. Mailing Address: 2016 RICE ROAD SANFORD, NC 27330-0000
 - c. Physical Address: ---- NC 82 NC

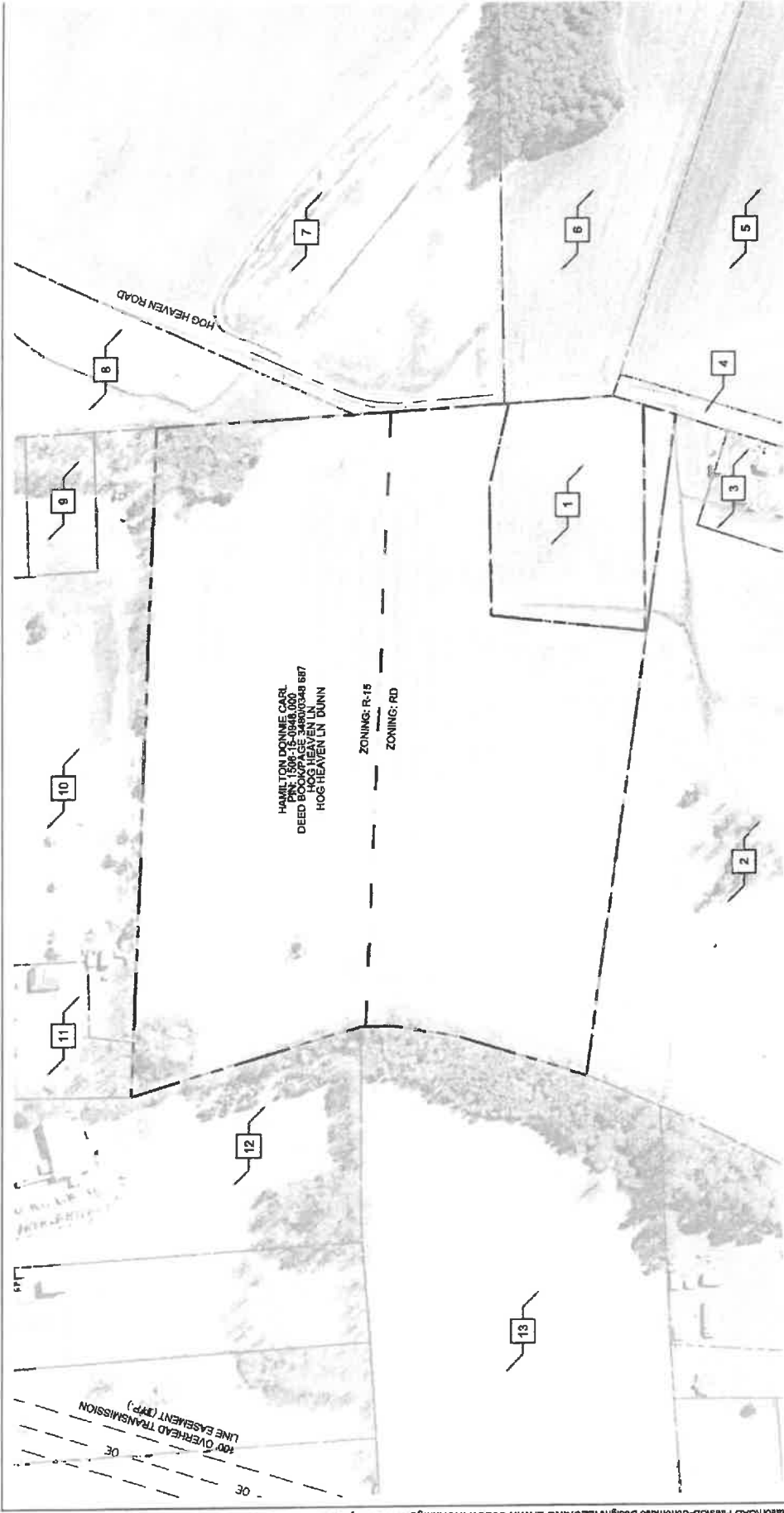

Location: R:\South River\Erwin Substation\CAD Files\SD-Schematic Design\REZONING-ERWIN-SUBSTATION.dwg Last Saved By: sthm Last Saved Date: 1/19/2024 1:07 PM Plot Date: 1/24/2024

Date: 1/24/2024
 Drawn By: SPF
 Approved: GSB
 Job No.: 8-317B
 ADJACENT PROPERTY OWNER:

SOUTH RIVER ELECTRIC
MEMBERSHIP CORPORATION
 ADJACENT PROPERTY OWNERS
 FOR REZONING APPLICATION OF THE
DONNIE CARL HAMILTON PROPERTY

115 OAKLAND AVE., STE. 102
 ROCK HILL, SC 29730
 TEL: 704.372.5873
 N.C. FIRM NO. F-0429

#	Revision	Date

SECE
 ECEPOWER.COM

R1.00

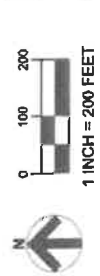

South River Electric
Membership Corporation
 A Tranche Energy Cooperative

- NOTES:**
1. THE PROPERTY SHOWN HEREON IS SUBJECT TO ALL EASEMENTS OF RECORD AFFECTING SAME.
 2. THIS DRAWING IS NOT INTENDED TO DEPICT ALL PHYSICAL CHARACTERISTICS, UTILITIES, TOPOGRAPHICAL INFORMATION, ETC. OF THE AREA SHOWN.
 3. THIS MAP IS NOT A CERTIFIED SURVEY AND HAS NOT BEEN REVIEWED BY ALL LOCAL GOVERNMENTAL AGENCY FOR COMPLIANCE WITH ANY APPLICABLE LAND DEVELOPMENT REGULATIONS.

NOTHING FROM PART OF TRACT 2 AND 3 AND PART OF TRACT 4

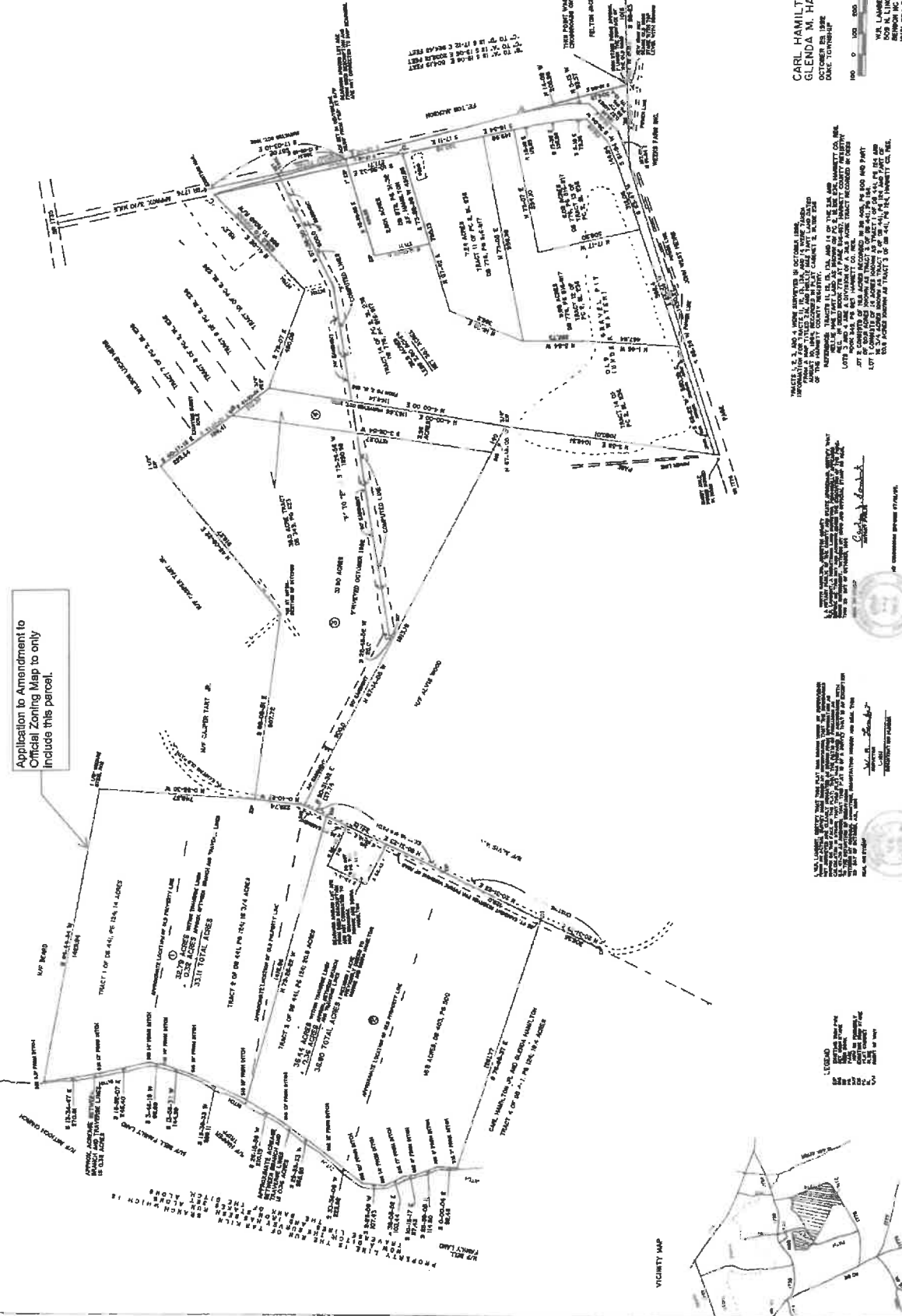

Application to Amendment to Official Zoning Map to only include this parcel.

CARL HAMILTON JR. AND WIFE, GLENDA M. HAMILTON. 1 ACRE, 500 FEET CORNER OF W. LAURET AND W. LINCOLN STREETS, HAMILTON COUNTY, MISSOURI.

TRACTS 1, 2, AND 3 HAVE BEEN DIVIDED INTO SEVERAL LOTS... INFORMATION FROM TRACTS 1, 2, 3, 4, 5, 6, 7, 8, 9, 10, AND 11... TRACTS 1, 2, 3, 4, 5, 6, 7, 8, 9, 10, AND 11... TRACTS 1, 2, 3, 4, 5, 6, 7, 8, 9, 10, AND 11...

LEGAL DESCRIPTION OF THE PARCELS... THE PARCELS ARE PART OF TRACTS 1, 2, 3, 4, 5, 6, 7, 8, 9, 10, AND 11... THE PARCELS ARE PART OF TRACTS 1, 2, 3, 4, 5, 6, 7, 8, 9, 10, AND 11...

LEGAL DESCRIPTION OF THE PARCELS... THE PARCELS ARE PART OF TRACTS 1, 2, 3, 4, 5, 6, 7, 8, 9, 10, AND 11... THE PARCELS ARE PART OF TRACTS 1, 2, 3, 4, 5, 6, 7, 8, 9, 10, AND 11...



FOR REGISTRATION
Kimberly S. Harrova
REGISTER OF DEEDS
Harnett County, NC
2017 FEB 16 09:48:28 AM
BK:348 Pg:348-351
FEE: \$28.00
INSTRUMENT # 2017002341
TRIMETER

HARNETT COUNTY TAX ID#
12-0595-0001-01
r-ek
2-14-17 BY SJ3



This instrument drafted by: Timothy C. Morris, P.A.
After recording, mail to: P.O. Box 794, Erwin, North Carolina 28339

NORTH CAROLINA)
HARNETT COUNTY) DEED

This deed, made and entered into this 15th day of February 2017, by and between Donnie Carl Hamilton, of Harnett County, North Carolina whose address is 2628 NC Hwy 82, Dunn, NC 28334 hereinafter referred to as the "GRANTOR"; and Donnie Carl Hamilton and wife Becky P. Hamilton, as tenants by the entirety, of Harnett County, North Carolina, whose address is: 2628 NC Hwy 82, Dunn, NC 28334; hereinafter referred to as the "GRANTEES".

WITNESSETH:

Now therefore, said Grantor, for and in consideration of the sum of one dollar, have bargained and sold and by these presents do grant, bargain, sell and convey to said Grantees, their heirs and assigns all right, title, interest, and estate of said Grantor, to a certain tract or parcel of land lying and being those certain tracts or parcels of land situated and being in Duke and Stewart's Creek Township, Harnett County, North Carolina, and more particularly described below. This is the same property that was conveyed to the Grantor in deed recorded in Book 1113, Page 630-633 at the Harnett County Register of Deeds Office.

Highlighted text references HAMILTON JR. CARL 10 29 92 PLAT provided.!

PARCEL ONE: BEGINNING at an existing 1 1/8 inch square steel rod, said rod being the northeastern corner for the Carl Hamilton, Jr. and wife, Glenda Hamilton 14 acre tract known as Tract 1 of Deed Book 441, at Page 124 of the Harnett County Registry, and runs as the old property line between Hamilton and Beard, North 84 degrees 44 minutes 54 seconds West 1429.94 feet to an iron stake, said stake being located 5.5 feet east of a ditch (formerly Tar Kiln Branch), with corner supposed to be in the run of the branch; thence as the run of the branch, surveyed and iron stakes set along the eastern bank of the ditch that was formerly Tar Kiln Branch with the old property lines of Hamilton and Antioch Church, the Bell Family Land, and Harper Tripp the following courses and distances: South 13 degrees 34 minutes 47 seconds East 270.81 feet to an iron stake located 13 feet east of the ditch, and South 16 degrees 52 minutes 07 seconds East 245.40 feet to an iron stake located 14 feet east of the ditch, and South 3 degrees 46 minutes 18 seconds West 68.69 feet to an iron stake 16 feet east of the ditch, and South 13 degrees 55 minutes 33 seconds West 144.99 feet to an iron stake 15 feet east of the ditch, and South 19 degrees 39 minutes 33 seconds West 289.11 feet to an iron stake 19 feet east of the ditch; thence a new line, South 79 degrees 26 minutes 22 seconds East 1416.66 feet to an iron stake in a path, said stake being the line of Alvis Wood; thence as the old property line of Wood and Hamilton and running as an old path, North 20 degrees 31 minutes 32 seconds East 137.74 feet to an iron stake, said stake being the southeastern corner for the Carl Hamilton, Jr. and wife, Glenda Hamilton 16 3/4 acre tract recorded as Tract 2 of Deed Book 441, at page 124 of the Harnett County Registry and being the northeastern corner for the Carl Hamilton Jr. and wife, Glenda Hamilton, 20.8 acre tract recorded as Tract 3 of Deed Book 441, at page 124 of the Harnett County Registry and being the southwestern corner for the Carl Hamilton Jr. 36.5 acre tract recorded in Deed Book 349, at page 623 of the Harnett County Registry; thence as the old property line and path between Tract 2 of Deed Book 441, at page 124 and the 36.5 acre tract, North 0 degrees 40 minutes 27 seconds West 229.74 feet to an existing iron pipe, said pipe being a corner for Casper Tart Jr. and being the northwestern corner for the 36.5 acre tract; thence as

the old property line of Hamilton and Tart, North 0 degrees 56 minutes 30 seconds West 749.57 feet to the point of beginning and contains 32.79 acres, more or less, within the traverse. The area between the traverse line and the ditch contains approximately 0.32 acres leaving a total acreage in this tract of 33.11 acres and is Tract 1 as shown on a map for Carl Hamilton, Jr. and wife, Glenda Hamilton, dated October 29, 1992 by W.R. Lambert, R.L.S.

There is conveyed with the above referenced parcel a right of way and easement for the purposes of ingress, egress and regress, over and across the lands of the grantor, said right of way and easement being more particularly described as follows:

Beginning at a point in the centerline of SR 1776, said point may be located by beginning at an existing 1 inch iron pipe, said pipe being the northeastern corner for the B.F. Hamilton 2.801 acre tract recorded in Deed Book 878, at Pages 31-32 of the Harnett County Registry, and running as an extension of the northern property line of the B.F. Hamilton 2.801 acre tract 29.69 feet to a point in the centerline of SR 1776; then running as the center of the road North 17 degrees 03 minutes 10 seconds West 328.51 feet to the BEGINNING POINT; thence from said BEGINNING POINT, runs as the centerline of a 50 foot wide easement, South 57 degrees 56 minutes 50 seconds West 600.0 feet to a point; thence as the centerline of a 50 foot wide easement, South 75 degrees 26 minutes 56 seconds West approximately 1690.99 feet to a point; thence South 22 degrees 45 minutes 52 seconds West 25 feet to a point in the old property line between Hamilton and Alvis Wood; thence as the southern side of a 50 foot wide easement, North 67 degrees 14 minutes 05 seconds West 900 feet to an iron stake, said stake being a joint corner for Alvis Wood and Hamilton, said stake being the southwestern corner for the Carl Hamilton, Jr. 36.5 acre tract recorded in Deed Book 349, at page 623 of the Harnett County Registry, and said stake being the northeastern corner for the Carl Hamilton, Jr. and wife, Glenda Hamilton 20.8 acre tract recorded as Tract 3 of Deed Book 441, at Page 124, Harnett County Registry, and the southeastern corner for the Carl Hamilton, Jr. and wife, Glenda Hamilton 16 3/4 acre tract recorded as Tract 2 of Deed Book 441, at page 124 of the Harnett County Registry; thence as the eastern side of a 25 foot wide easement, South 20 degrees 31 minutes 32 seconds West 137.74 feet to an iron stake, corner for Tract 1 and Tract 2 of the Carl Hamilton, Jr. and wife, Glenda Hamilton Division as shown on a map dated October 29, 1992; thence continuing as the eastern property line of Carl Hamilton, Jr., and as the eastern side of a 25 foot wide easement, South 20 degrees 31 minutes 23 seconds West 1149.12 feet to the southeastern corner for Tract 2 of the Carl Hamilton, Jr. and wife, Glenda Hamilton Division as shown on a map dated October 29, 1992. With the above described 600 foot line being the centerline of the 50 foot wide easement and the above describe approximately 1690.99 foot line also being the centerline of the 50 foot wide easement and the above described 900 foot line being the southern line of the 50 foot wide easement and the above described 137.74 foot line and the 1149.12 foot line being the eastern line of the 25 foot wide easement with the purpose of the easement being for ingress and egress.

PARCEL TWO: BEGINNING at an iron stake at the high bank of the Cape Fear River, said stake being located at the south end of Red Rock Lock, said stake also being a corner for the Inez Corbin 200 acre "Williams Tract", and runs as the old line of Carl Hamilton, Jr. and Corbin, North 67 degrees 05 minutes 44 seconds West 48.57 feet to an iron stake set on the property line; thence as the old line of Hamilton and Corbin, North 67 degrees 05 minutes 44 seconds West 780.45 feet to an existing iron pipe at the intersection of ditches, corner chops were also found; thence as the line of Hamilton and Corbin, and as a ditch, South 7 degrees 59 minutes 05 seconds West 2184.31 feet to an existing iron stake at the intersection of ditches; thence as the old line of Hamilton, South 63 degrees 27 minutes 54 seconds West 152.95 feet to a set iron stake; thence as the line of Hamilton and Corbin, South 22 degrees 20 minutes 00 seconds West 785.0 feet to a set 5/8 inch steel rod over a tile that is at the northern side of a 50 feet wide right of way; thence as the line of Hamilton and Corbin, North 85 degrees 00 minutes 00 seconds West 500.00 feet to an existing concrete monument; thence as the line of Hamilton and Corbin, North 78 degrees 40 minutes 00 seconds West 650.13 feet to an existing concrete monument; thence as the line of Hamilton and Wellons, South 22 degrees 19 minutes 31 seconds West 671.3 feet to an iron stake, a new corner, also a corner for Tract #2; thence as a new line and as the line between Tract #1 and Tract #2, South 83 degrees 21 minutes 53 seconds East 2855.68 feet to an iron stake at the high bank of Cape Fear River, a new corner; thence as the run of Cape Fear River, measured along the high bank, the following courses and distances: North 9 degrees 57 minutes 25

seconds West 199.35 feet to an iron stake, and North 12 degrees 12 minutes 35 seconds West 200.95 feet to an iron stake, and North 5 degrees 55 minutes 20 seconds West 275.24 feet to an iron stake, and North 8 degrees 24 minutes 00 seconds West 182.41 feet to an iron stake, and North 0 degrees 23 minutes 05 seconds East 391.94 feet to an iron stake, and North 6 degrees 45 minutes 40 seconds East 571.28 feet to an iron stake, and North 7 degrees 33 minutes 10 seconds East 201.51 feet to an iron stake, and North 2 degrees 37 minutes 20 seconds East 319.44 feet to an iron stake, and North 7 degrees 14 minutes 10 seconds East 300.11 feet to an iron stake, and North 4 degrees 01 minute 15 seconds East 197.23 feet to an iron stake, and North 4 degrees 36 minutes 05 seconds East 420.16 feet to an iron stake, and North 2 degrees 37 minutes 55 seconds West 176.44 feet to the point of beginning and contains 101.14 acres, more or less.

There is conveyed with the above referenced parcel a 50 foot right of way and easement for the purposes of ingress, egress and regress, over and across the lands of the grantor, said right of way and easement being more particularly described as follows:

Beginning at an existing concrete monument, said monument being the joint corner between Carl Hamilton, Jr., Wellons, and Inez Corbin's 200 acre "Williams Tract", said monument may also be located by beginning at a P.K. nail over a culvert in the center of SR 1779, and running as the center of the road, North 78 degrees 48 minutes 18 seconds East 748.80 feet to a P.K. nail, and North 65 degrees 22 minutes 18 seconds East 224.64 feet to a P.K. nail and then running as the center of an existing path, South 66 degrees 11 minutes 21 seconds East 188.63 feet to an iron stake and South 68 degrees 33 minutes 31 seconds East 516.83 feet to an iron stake, and South 67 degrees 04 minutes 41 seconds East 506.74 feet to an iron stake, and South 77 degrees 50 minutes 31 seconds East 627.0 feet to the BEGINNING POINT; thence from said BEGINNING POINT, runs as the northern side of a 50 foot wide right of way and as the line of Hamilton and Inez Corbin, South 78 degrees 40 minutes 00 seconds East 650.13 feet to an existing concrete monument, and South 85 degrees 00 minutes 00 seconds East 500.0 feet to a set 5/8 inch steel rod over a tile; thence traversing from the northern side of a 50 foot wide right of way to the southern side, South 80 degrees 09 minutes 11 seconds East 1047.68 feet to an iron stake; thence as the western side of a 50 foot wide right of way, South 5 degrees 27 minutes 31 seconds East 642.23 feet to an iron stake, and South 36 degrees 41 minutes 08 seconds West 568.48 feet to an iron stake, and South 35 degrees 24 minutes 23 seconds West 1024.36 feet to an iron stake, and South 39 degrees 08 minutes 58 seconds West 1053.90 feet to an iron stake, and South 38 degrees 25 minutes 08 seconds West 440.73 feet to an iron stake, said stake being in the property line between Tract #3 and Tract #4, and being located North 62 degrees 09 minutes 02 seconds West 1431.48 feet from an iron stake at the high bank of the Cape Fear River that is a joint corner for Tract #4 and Tract #3, and being located South 62 degrees 09 minutes 02 seconds East 1645.4 feet from an iron stake in the line of Wellons that is a joint corner for Tract #4 and Tract #3 with the above described lines being a 50 foot wide easement for the purpose of ingress and egress for Tracts #1, #2, #3, and #4 of the Carl Hamilton, Jr. Division.

No title search was performed

To have and to hold said lands and premises, together with all privileges and appurtenances thereunto belonging, to the said Grantees and their heirs and assigns in equal shares as tenants in common.

And the said Grantor does covenant that he is seized of said premises in fee and has the right to convey the same in fee simple; that the same are free from encumbrances; and that he will warrant and defend the said title to the same against the claims of all persons whomsoever.

IN TESTIMONY WHEREOF, said Grantor has hereunto set his hand and seal the day and year first above written.

 (SEAL)
Donnie Carl Hamilton

NORTH CAROLINA

HARNETT COUNTY

I, Karen P. Lamm, a Notary Public for said County and State, certify that Donnie Carl Hamilton personally appeared before me this day and acknowledged the execution of the foregoing instrument.

Witness my hand and seal, this the 15th day of February, 2017.



Notary Public

My Commission Expires: September 21, 2020





**REZONING MAP REQUEST
STAFF REPORT**

Case: ZT-2024-001

Dylan Eure, Town Planner
deure@erwin-nc.org

Phone: (910) 591-4201 Fax: (910) 897-5543

Planning Board: 2/19/2024

Town Commissioners: 03/07/2024

The Town of Erwin has received a request to rezone a parcel located by its Harnett County Tax Pin 1506-15-0948. Currently this parcel is split zoned between R-15 and RD. With R-15 occupying approximately 15.55 acres or 53.27% of the property, and RD occupying approximately 13.67 acres or 46.73% of the property. Said petition would rezone the above parcel to be entirely under RD zoning classification.

Applicant Information

Owner of Record:

Name: Carl & Becky Hamilton

Address: 687 Hog Heaven Ln

City/State/Zip: Dunn, NC 28334

Applicant:

Name: Carl & Becky Hamilton

Address: 687 Hog Heaven Ln

City/State/Zip: Dunn, NC 28334

Property Description

Harnett County Tax Pin #1506-15-0948

Vicinity Map

- See Attached Harnett County GIS Image with zoning districts
- See Attached Harnett County GIS Image without zoning districts

Physical Characteristics

Site Description:

A single vacant parcel totaling 29.19 acres located off of Hog Heaven Rd within Erwin's planning jurisdiction approximately .35 of a mile south of town limits. According to Harnett

County GIS no water or sewer lines are accessible through the property. Property is within both watershed HUC8 and HUC12 which will require approval from North Carolina's Department of Environmental Quality prior to development taking place. Otherwise the property is not within a flood zone or wetland.

Surrounding Land Uses: The surrounding land uses are R-15 to the North and to the West with RD being South and East of the parcel.

Services Available

- No water or sewer lines run by property.
-
-

Staff Evaluation

The applicant has requested to have a single split zoned parcel between R-15 and RD zoning classifications to be entirely under the RD.

Staff Evaluation

Yes No The IMPACT to the adjacent property owners and the surrounding community is reasonable, and the benefits of the rezoning outweigh any potential inconvenience or harm to the community

- **Reasoning:** The rezoning is compatible with the surrounding community and would not cause any inconvenience to the those within the area.

Yes No The requested zoning district is COMPATIBLE with the existing Land Use Classification.

- **Reasoning:** According to Erwin's current Land Use Plan done in 2023 the property is assigned to be zoned as an suburban area.

Yes No The proposal does ENHANCE or maintain the public health, safety, and general welfare.

- **Reasoning:** The rezoning would allow for additional developments on property that are currently not allowed due to the parcel being split zoned.

Yes No The request is for a SMALL SCALE REZONING and should be evaluated for reasonableness.

- **Reasoning:** This rezoning request includes a single parcel to be rezoned to be completely zoned under RD.

<p>There is a convincing demonstration that all uses permitted under the proposed district classification would be in the general public interest and not merely in the interest of an individual or small group. YES</p>	<p>Parcel is currently split zoned making it challenging to develop. By rezoning to be entirely under the RD zoning classification it would allow for all permitted uses under said zoning district to occur.</p>
<p>There is a convincing demonstration that all uses permitted under the proposed district classification would be appropriate in the area included in the proposed change. (When a new district designation is assigned, any use permitted in the district is allowable, so long as it meets district requirements, and not merely uses which applicants state they intend to make of the property involved.) YES</p>	<p>The rezoning would place the entire parcel under RD and all permitted uses along with it. Furthermore, the parcel is not within corporate limits of the Town.</p>
<p>There is a convincing demonstration that the character of the neighborhood will not be materially and adversely affected by any use permitted in the proposed change. YES</p>	<p>The parcel is currently split zoned under both RD and R-15 zoning classification. This would ensure all RD classification and uses on the parcel.</p>
<p>The proposed change is in accord with the Land Development Plan and sound planning principles. YES</p>	<p>The Erwin 2023 Land Use Plan has this parcel of land to be zoned under suburban classifications and by the rezoning would solve the issue of being split zoned.</p>

Statement of Consistency

The requested rezoning from being split zoned with R-15 and RD to entirely with RD classification is compatible with all of the Town of Erwin’s regulatory documents. According to Erwin’s 2023 Land Use Plan and Erwin’s Code of Ordinances the uses defined within the RD zoning classification would best serve the above stated parcel. It is recommended that this rezoning request be **Approved**.

Attachments:

- ZT-2024-001 Application
- Harnett County GIS Image with zoning districts
- Harnett County GIS Image without zoning districts
- Adjacent property owner sheet

Harnett GIS

NOT FOR LEGAL USE







Harnett County GIS



Harnett COUNTY
NORTH CAROLINA

GIS/E-911 Addressing
January 24, 2024

 Flood Map Index	 County Boundary	 Easements	 Other	 Parcels	 Watershed HUC8
 Address Numbers	 RoadCenterlines	 Watershed HUC12	 RD	 ETJ Boundary	 Zoning Districts
 R15	 RA-30				



N
W E
S



0 165 330 660 Feet

Harnett GIS

NOT FOR LEGAL USE





Harnett COUNTY
NORTH CAROLINA

GIS/E-911 Addressing
January 24, 2024

County Water Mains
6 - 36

Watershed HUC8
6 - 36

Flood Map Index
 County Boundary
 ○ Address Numbers

County Water Mains
 Easements
 ○ Other

Road Centerlines
 Watershed HUC12
 ○ Parcels

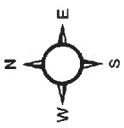

N
W E
S



0 165 330 660 Feet

John Smith Jr
1174 Old Hamilton Rd
Dunn, NC 28334

Carl Donnie & Becky P Hamilton
687 Hog Heaven Ln
Dunn, NC 28334

Carl Ronnie & Debra Lynn Hamilton
473 Hog Heaven Ln
Dunn, NC 28334

Carl R. & Debra Hamilton
473 Hog Heaven Ln
Dunn, NC 28334

Carl Hamilton Jr Heirs
2628 NC HWY 82
Dunn, NC 28334

Sharon & Stephen Lewis
1057 Hudsonstown Rd
Dunn, NC 28334

Kevin Jacob Lee
383 Hinson Rd
Dunn, NC 28334

Anchor Properties of Raleigh
503 Wrennstone Ct
Apex, NC 27529

Edwin Frankie Harant
111 Lavendale Ln
Dunn, NC 28334

Larry & Roxanne Baird
135 Lavendale Ln
Dunn, NC 28334

Robert & Melody Jenkins
114 Lavendale Ln
Dunn, NC 28334

Don Davis Trustee & Antioch Pentecostal
Free Will
PO Box 2005
Dunn, NC 28334

Shirley B Matthews
2016 Rice Rd
Sanford, NC 27330



TOWN OF ERWIN

P.O. Box 459 · Erwin, NC 28339
Phone: 910-897-5140 · Fax: 910-897-5543
www.erwin-nc.org

2/23/2024

Notice of a Public Hearing ZT-2024-001

Mayor
Randy L. Baker
Mayor Pro Tem
Ricky W. Blackmon
Commissioners
Alvester L. McKoy
Timothy D. Marbell
Charles L. Byrd
David L. Nelson
William R. Turnage

The Board of Commissioners of the Town of Erwin will hold a public hearing pursuant to NC General Statute 160D-406 on March 7th, 2024 at 7:00 P.M. at the Erwin Town Hall, 100 West F Street, Erwin, North Carolina to hear public comment on a proposed rezoning request.

There has been a zoning map amendment application submitted to the Town. The rezoning request includes a single parcel of land that are listed below:

- HC Tax Pin: 1506-15-0948.000 located off of Hog Heaven Ln in Erwin's planning jurisdiction.

Currently this parcel is split zoned between R-15 and RD. With R-15 occupying approximately 15.55 acres or 53.27% of the property, and RD occupying approximately 13.67 acres or 46.73% of the property. Said petition would rezone the above parcel to be entirely under RD zoning classification.

A copy of this case is available for review at the Erwin Town Hall. Questions concerning this case can be addressed to the Town Planner Dylan Eure at 910-591-4201 or by email at deure@erwin-nc.org

Regards,

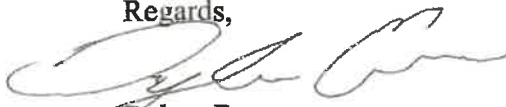

Dylan Eure
Town Planner

NOTICE OF PUBLIC HEARING

The Town of Erwin Board of Commissioners will conduct a Public Hearing on the following item pursuant to NC General Statute 160D-406, on Thursday, March 7, 2024, at 7:00 P.M. in the Erwin Municipal Building Board Room located at 100 West F Street, Erwin, NC 28339. Questions can be addressed to the Town Manager Snow Bowden at 910-591-4200 or by email at townmanager@erwin-nc.org.

- Case ZT-2024-001: Request to have a split-zoned parcel located off of Hog Heaven Lane rezoned from R-15 and RD to entirely Rural District (RD). The property can be identified by its Harnett County Tax PIN # 1506-15-0948.000.
- Text Amendment to Chapter 36 Zoning, Section 36-115 Permitted uses and structures under Article 5 Residential (R-15) and Article 2 Definitions in the Town of Erwin Code of Ordinances.
- Text Amendment to Chapter 12 Environment, Article IV Weeds, Hedges, Tall Grass and Other Vegetation, Section 12-92 Definition in the Town of Erwin Code of Ordinances.
- A request to consider permanently closing an undeveloped section of Bayles Street that extends from the parcel that the Walmart is located on currently.

This case is available for review at the Erwin Town Hall. All persons desiring to be heard either for or against the proposed items set forth above are requested to be present at the above-mentioned time and place.
2/20,27/2024

ZT-2024-001

Statement-of-Consistency

The requested rezoning from being split zoned with R-15 and RD to entirely with RD classification is compatible with all of the Town of Erwin's regulatory documents. According to Erwin's 2023 Land Use Plan and Erwin's Code of Ordinances the uses defined within the RD zoning classification would best serve the above stated parcel. It is recommended that this rezoning request be **Approved**.

Randy Baker
Mayor

Lauren Evans
Town Clerk

ZT-2024-001

Statement-of-Inconsistency

The requested rezoning from being split zoned with R-15 and RD to entirely with RD classification is not compatible with all of the Town of Erwin's regulatory documents. According to Erwin's 2023 Land Use Plan and Erwin's Code of Ordinances the uses defined within the RD zoning classification would not best serve the above-stated parcel. It is recommended that this rezoning request be **Not Approved**.

Randy Baker
Mayor

Lauren Evans
Town Clerk

Erwin Board of Commissioners

REQUEST FOR CONSIDERATION

To: The Honorable Mayor and Board of Commissioners

From: Snow Bowden, Town Manager

Date: February 26, 2024

Subject: ZT-2024-002

Town Staff has prepared a minor rezoning map amendment. The proposed zoning map amendment addresses a handful of the parcels that are split-zoned in our Town Limits, primarily around the Moulton Springs Road area. Town Staff has already spoken with the majority of the property owners and informed them of what we were doing and why we were doing it. The majority of them supported the effort. As a reminder, discussed doing this around two years ago but we did not because at that time the tax reevaluation was underway and we knew that property values were going to go up significantly so we held off.

This proposal does not address all of the split-zoned lots in our jurisdiction. Town Staff thought it would be best to break the proposals into smaller portions to present. The Planning Board recommended all of these parcels be rezoned to the districts identified in the following memo.

If there are no questions about this proposal we will need to set a public hearing date for our April Town Board meeting before we can approve an ordinance for these parcels to be rezoned. We will need to ensure that all of the public notice requirements are fulfilled before we can have the public hearing.



TOWN OF ERWIN

P.O. Box 459 • Erwin, NC 28339
Ph: 910-897-5140 • Fax: 910-897-5543
www.erwin-nc.org

Mayor
Randy L. Baker
Mayor Pro Tem
Ricky W. Blackmon
Commissioners
Alvester L. McKoy
Timothy D. Marbell
Charles L. Byrd
David L. Nelson
William R. Turnage

2/26/2024

ZT-2024-002 Memorandum

Rezoning Description

The Town of Erwin Staff wishes to request to rezone eight (8) parcels located off of Moulton Springs Rd and S 13th St for the purpose of correcting split zoned parcels and four (4) incorrectly zoned parcels to be entirely under the zoning classification in which is currently being primarily used. Said parcels are as followed...

- 308 Moulton Springs Rd – **Rezone to full R-10**
- HC Tax Pin 0597-51-6406 – **Rezone to full R-10**
- 309 Moulton Springs Rd – **Rezone to full R-6**
- HC Tax Pin 0597-51-7332 - **Rezone to full R-6**
- 305 Moulton Springs Rd – **Rezone to full R-6**
- 203 Moulton Springs Rd – **Rezone to full R-6**
- 825 S 13th St – **Rezone to full R-10**
- 808 S 13th St – **Rezone to full B-2**
- 814 S 13th St – **Rezone to full R-6**
- 812 S 13th St – **Rezone to full R-6**
- 201 Moulton Springs Rd- **Rezone to full R-6**
- 106 Ennis St- **Rezone to full R-10**

Property Description

- 308 Moulton Springs Rd
 - Home on Property, no change to home owner except increase in dimensional requirements.
 - R-10: 1.77 Acres, 84%
 - R-6: .33 Acres, 16%
 - **Rezone to full R-10**
- HC Tax Pin 0597-51-6406
 - No home on Property, only accessory structures for 302 Moulton Springs, no change to home owner except increase in dimensional requirements.
 - R-10 .55 Acres, 69%

- R-6 .25 Acres, 31%
 - **Rezone to full R-10**
- 309 Moulton Springs Rd
 - Home on the Property, B-2 zoning would prevent owners from building onto the home.
 - B-2 .23 Acres, 64.43%
 - R-6 .15 Acres, 35.57%
 - **Rezone to full R-6**
- HC Tax Pin 0597-51-7332
 - Too small of a parcel to develop .05 acres.
 - R-6 .04 Acres, 82.33%
 - B-2 .01 Acres, 17.67%
 - **Rezone to full R-6**
- 305 Moulton Springs Rd
 - Homes on property, no change to homeowner.
 - Two Primary Structures on property
 - R-6 1.01 Acres, 70.42%
 - B-2 .42 Acres, 29.58%
 - **Rezone to full R-6**
- 203 Moulton Springs Rd
 - Home on Property B-2 zoning would prevent owners from building onto the home.
 - B-2 .42 Acres, 95.71%
 - R-6 .02 Acres. 11.9%
 - **Rezone to full R-6**
- 825 S 13th St
 - Home on Property, no change to homeowner, would only increase dimensional requirements.
 - R-10 3.19 Acres, 94.87%
 - B-2 .0 Acres, .12%
 - R-6 .17 Acres, 5.01%
 - **Rezone to full R-10**
- 808 S 13th St
 - Business location- The Gettin' Place, No change to owner
 - B-2 .42 Acres, 95.71%
 - R-6 .02 Acres, 4.29%
 - **Rezone to Full B-2**
- 814 S 13th St
 - B-2 zoned while a SFD currently occupies the property
 - Parcel too small to develop
 - **Rezone to full R-6**
- 812 S 13th St
 - B-2 zoned while a SFD currently occupies the property

- Parcel too small to develop
 - **Rezone to full R-6**
- 201 Moulton Springs Rd
 - B-2 zoned while a SFD currently occupies the property
 - **Rezone to full R-6**
- 106 Ennis St
 - B-2 zoned while a SFD currently occupies the property
 - **Rezone to full R-10**

Findings of Fact

Surrounding Land Uses: The surrounding land uses for all of the 8 parcels are as followed

- Conservation to the West
- B-2 to the East / North East
- R-10 to the North and South
- R-6 to the East
-

The requested rezoning from being split zoned is compatible with all of the Town of Erwin's regulatory documents. According to Erwin's 2023 Land Use Plan and Erwin's Code of Ordinances the uses defined within the mixed use classification would best serve the above stated parcels. It is recommended that this rezoning request be **Approved**.

Regards,

Dylan Eure
Town Planner



**REZONING MAP REQUEST
STAFF REPORT**

Case: ZT-2024-002

Dylan Eure, Town Planner

deure@erwin-nc.org

Phone: (910) 591-4201 Fax: (910) 897-5543

Planning Board: 2/19/2024

Town Commissioners: TBD

The Town of Erwin Staff wishes to request to rezone eight (8) parcels located off of Moulton Springs Rd and S 13th St for the purpose of correcting split zoned parcels and four (4) incorrectly zoned parcels to be entirely under the zoning classification in which is currently being primarily used. Said parcels are as followed...

- 308 Moulton Springs Rd – **Rezone to full R-10**
- HC Tax Pin 0597-51-6406 – **Rezone to full R-10**
- 309 Moulton Springs Rd – **Rezone to full R-6**
- HC Tax Pin 0597-51-7332 - **Rezone to full R-6**
- 305 Moulton Springs Rd – **Rezone to full R-6**
- 203 Moulton Springs Rd – **Rezone to full R-6**
- 825 S 13th St – **Rezone to full R-10**
- 808 S 13th St – **Rezone to full B-2**
- 814 S 13th St – **Rezone to full R-6**
- 812 S 13th St – **Rezone to full R-6**
- 201 Moulton Springs Rd- **Rezone to full R-6**
- 106 Ennis St- **Rezone to full R-10**

Applicant Information

Owners of Record:

Name: Kimber Group
Address: 308 Moulton Springs / Mailing
Address PO Box 181
City/State/Zip: Erwin, NC 28339

Name: Margaret Bradshaw
Address: HC Tax Pin 0597-51-6406 / Mailing
Address 302 Moulton Springs
City/State/Zip: Erwin, NC 28339

Name: Linda Lou Westbrook
Address: 309 Moulton Springs
City/State/Zip: Erwin, NC 28339

Name: Delauriel Deck Matthews
Address: HC Tax Pin 0597-51-7232 / Mailing
Address 305 Moulton Springs
City/State/Zip: Erwin, NC 28339

Name: Delauriel Deck Matthews
Address: 305 Moulton Springs
City/State/Zip: Erwin, NC 28339

Name: Sara Collins Tyndall
Address: 203 Moulton Springs
City/State/Zip: Erwin, NC 28339

Name: Dianna Jackson Barefoot
Address: 825 S 13th / Mailing Address 1434
Neills Creek Rd
City/State/Zip: Erwin, NC 28339 / Lillington, NC
27546

Name: Edward Neil Parker
Address: 808 S 13th / Mailing Address 915 S
13th
City/State/Zip: Erwin, NC 28339

Name: Eller Rental Properties
Address: 814 S 13th / Mailing Address PO
Box 2228
City/State/Zip: Erwin, NC 28339 / Lillington, NC
27546

Name: Eller Rental Properties
Address: 812 S 13th / Mailing Address PO
Box 2228
City/State/Zip: Erwin, NC 28339/ Lillington, NC
27546

Name: John Henry Williams
Address: 201 Moulton Springs / Mailing
Address 100 B Pope St
City/State/Zip: Erwin, NC 28339

Name: Mason Gordon
Address: 106 Ennis St / Mailing Address 55
Pete Mason Dr

City/State/Zip: Erwin, NC 28339 / Spring Lake, NC
28390

Applicant:

Name: Town of Erwin

Address: 100 West F St

City/State/Zip: Erwin, NC 28339

Property Description

- 308 Moulton Springs Rd
 - Home on Property, no change to home owner except increase in dimensional requirements.
 - R-10: 1.77 Acres, 84%
 - R-6: .33 Acres, 16%
 - **Rezone to full R-10**
- HC Tax Pin 0597-51-6406
 - No home on Property, only accessory structures for 302 Moulton Springs, no change to home owner except increase in dimensional requirements.
 - R-10 .55 Acres, 69%
 - R-6 .25 Acres, 31%
 - **Rezone to full R-10**
- 309 Moulton Springs Rd
 - Home on the Property, B-2 zoning would prevent owners from building onto the home.
 - B-2 .23 Acres, 64.43%
 - R-6 .15 Acres, 35.57%
 - **Rezone to full R-6**
- HC Tax Pin 0597-51-7332
 - Too small of a parcel to develop .05 acres.
 - R-6 .04 Acres, 82.33%
 - B-2 .01 Acres, 17.67%
 - **Rezone to full R-6**
- 305 Moulton Springs Rd
 - Homes on property, no change to homeowner.
 - Two Primary Structures on property
 - R-6 1.01 Acres, 70.42%
 - B-2 .42 Acres, 29.58%
 - **Rezone to full R-6**
- 203 Moulton Springs Rd
 - Home on Property B-2 zoning would prevent owners from building onto the home.

- B-2 .42 Acres, 95.71%
- R-6 .02 Acres. 11.9%
- **Rezone to full R-6**
- 825 S 13th St
 - Home on Property, no change to homeowner, would only increase dimensional requirements.
 - R-10 3.19 Acres, 94.87%
 - B-2 .0 Acres, .12%
 - R-6 .17 Acres, 5.01%
 - **Rezone to full R-10**
- 808 S 13th St
 - Business location- The Gettin' Place, No change to owner
 - B-2 .42 Acres, 95.71%
 - R-6 .02 Acres, 4.29%
 - **Rezone to Full B-2**
- 814 S 13th St
 - B-2 zoned while a SFD currently occupies the property
 - Parcel too small to develop
 - **Rezone to full R-6**
- 812 S 13th St
 - B-2 zoned while a SFD currently occupies the property
 - Parcel too small to develop
 - **Rezone to full R-6**
- 201 Moulton Springs Rd
 - B-2 zoned while a SFD currently occupies the property
 - **Rezone to full R-6**
- 106 Ennis St
 - B-2 zoned while a SFD currently occupies the property
 - **Rezone to full R-10**

Vicinity Map

- See Attached Harnett County GIS Image with zoning districts
- See Attached Harnett County GIS Image without zoning districts

Physical Characteristics

Site Description:

Total of 12 parcels with 7 located on Moulton Springs Road, 4 on S 13th Street, and 1 on Ennis in which all are within approximately .15 miles or 300 yards of each other. All parcels that are

included have access to Harnett County water and sewer lines. According to Harnett GIS there are no wetlands, watersheds, or flood areas within any of the parcels discussed. Furthermore according to GIS there are no recorded easements through any of the properties. The exact acreage for each of the parcels are as followed.

- 308 Moulton Springs Rd -2.10 acres
- HC Tax Pin 0597-51-6406 - .80 acres
- 309 Moulton Springs Rd - .36 acres
- HC Tax Pin 0597-51-7332 - .05 acres
- 305 Moulton Springs Rd -1.43 acres
- 203 Moulton Springs Rd -.31 acres
- 825 S 13th St – 3.36 acres
- 808 S 13th St - .44 acres
- 814 S 13th St- .06 acres
- 812 S 13th St- .07 acres
- 201 Moulton Springs - .42 acres
- 106 Ennis St- .32 acres

Surrounding Land Uses: The surrounding land uses for all of the 8 parcels are as followed

- Conservation to the West
- B-2 to the East / North East
- R-10 to the North and South
- R-6 to the East

Services Available

- Harnett County Water and Sewer are accessible for all properties.

Staff Evaluation

The Town of Erwin has requested 12 parcels to be rezoned to correct zoning map conformities to align parcels to a single zoning classification in which fits each parcel best based on their current use.

Staff Evaluation

Yes No The IMPACT to the adjacent property owners and the surrounding community is reasonable, and the benefits of the rezoning outweigh any potential inconvenience or harm to the community

- **Reasoning:** The rezoning's are compatible with the surrounding community and would not cause any inconvenience to those within the area.

Yes No The requested zoning district is COMPATIBLE with the existing Land Use Classification.

- **Reasoning:** According to Erwin's current Land Use Plan done in 2023 the properties are assigned to be zoned under mixed use that promotes residential and commercial uses.

Yes No The proposal does ENHANCE or maintain the public health, safety, and general welfare.

- **Reasoning:** The rezoning would correct zoning nonconformities and ensure that clear uses are defined for the parcels.

Yes No The request is for a SMALL SCALE REZONING and should be evaluated for reasonableness.

- **Reasoning:** This rezoning request includes 12 parcels all within less than .15 of a mile between each other.

<p>There is a convincing demonstration that all uses permitted under the proposed district classification would be in the general public interest and not merely in the interest of an individual or small group. YES</p>	<p>Parcels are currently split zoned and by rezoning would ensure that their current uses are permitted.</p>
<p>There is a convincing demonstration that all uses permitted under the proposed district classification would be appropriate in the area included in the proposed change. (When a new district designation is assigned, any use permitted in the district is allowable, so long as it meets district requirements, and not merely uses which applicants state they intend to make of the property involved.) YES</p>	<p>All parcels are designated under the Erwin 2023 Land use Plan to be either residential or mixed use.</p>
<p>There is a convincing demonstration that the character of the neighborhood will not be materially and adversely affected by any use permitted in the proposed change. YES</p>	<p>The rezoning's would not alter the character of the neighborhood in anyway. Rezoning's would ensure clarity for owners and not take away rights that they currently have to their land.</p>
<p>The proposed change is in accord with the Land Development Plan and sound planning principles. YES</p>	<p>All of the parcels that are included are designated to be mixed in the 2023 Erwin Land Use Plan for the purposes of residential and commercial.</p>

Statement of Consistency

The requested rezoning from being split zoned is compatible with all of the Town of Erwin's regulatory documents. According to Erwin's 2023 Land Use Plan and Erwin's Code of Ordinances the uses defined within the mixed use classification would best serve the above stated parcels. It is recommended that this rezoning's request be **Approved**.

Attachments:

- ZT-2024-002 Application
- ZT-2024-002 Memo
- Harnett County GIS Image with zoning districts
- Harnett County GIS Image without zoning districts
- Adjacent property owner sheets
- Public notice letter sent to adjacent property owners

308 Moulton Springs



HC Tax Pin 0597-51-6406



309 Moulton Springs



HC Tax Pin 0597-51-7232

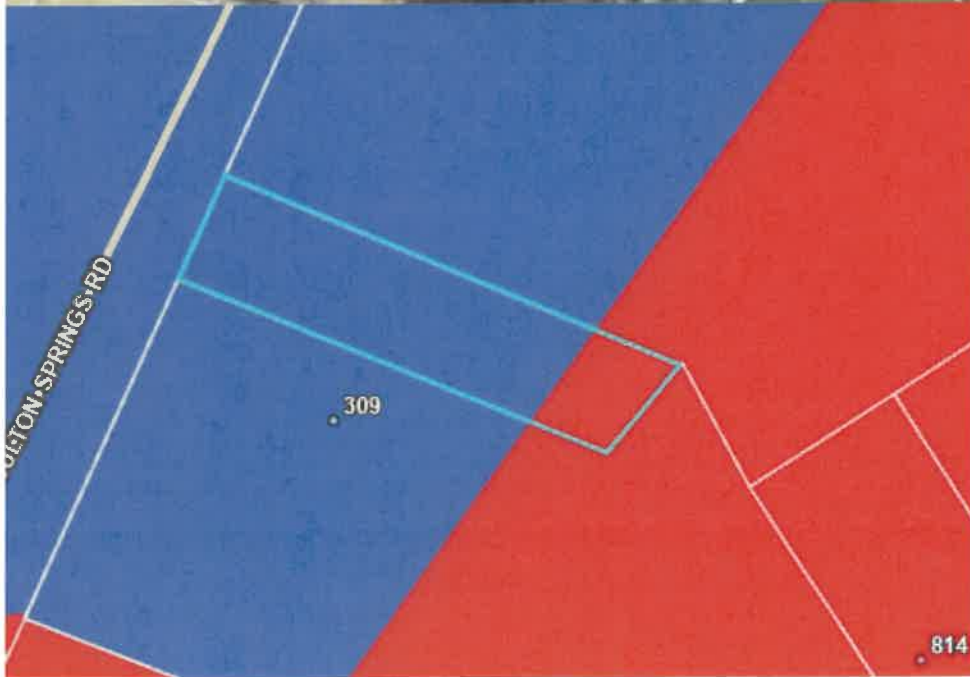

305 Moulton Springs



203 Moulton Springs

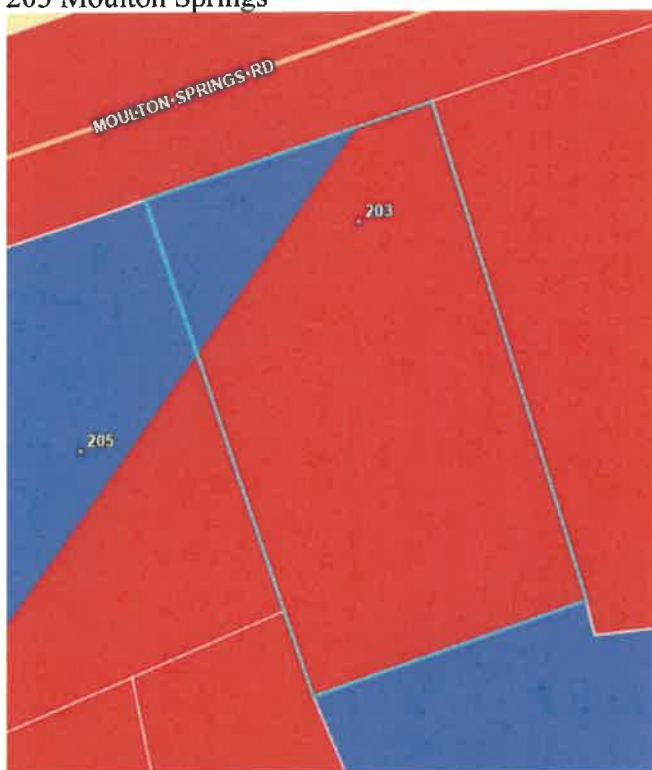

825 S 13th

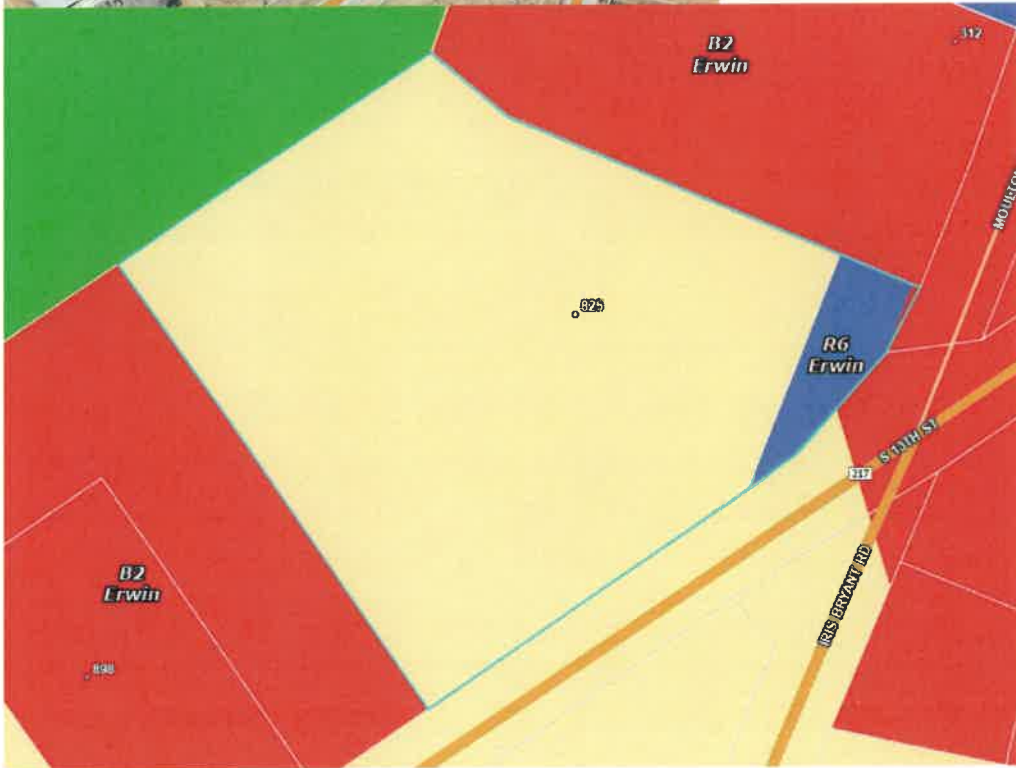

808 S 13th



814 S 13th



812 S 13th

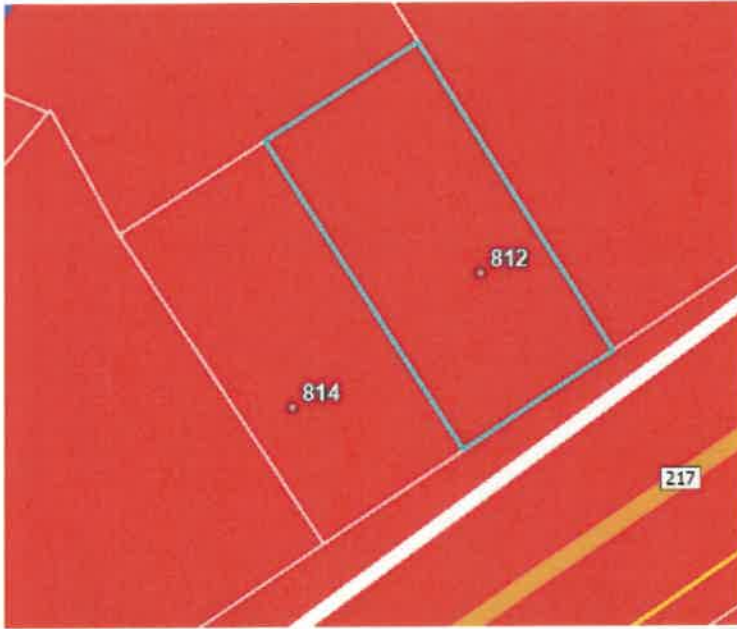

201 Moulton Springs

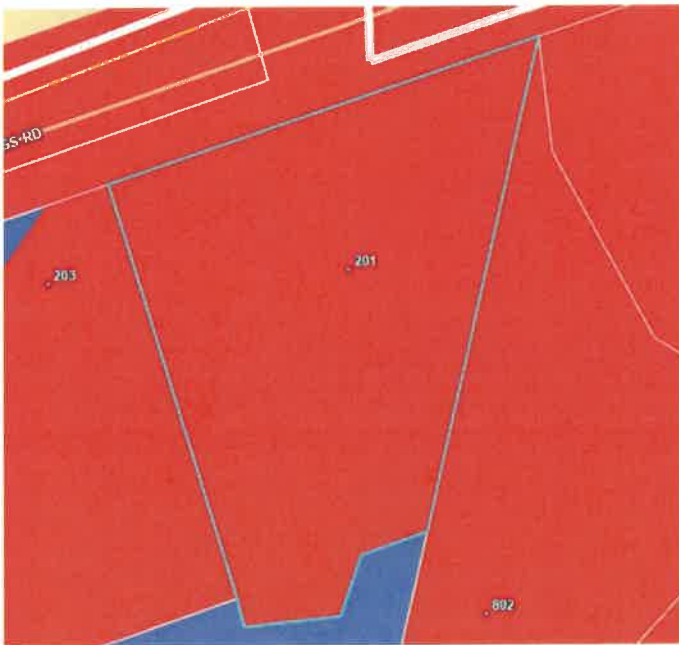

106 Ennis

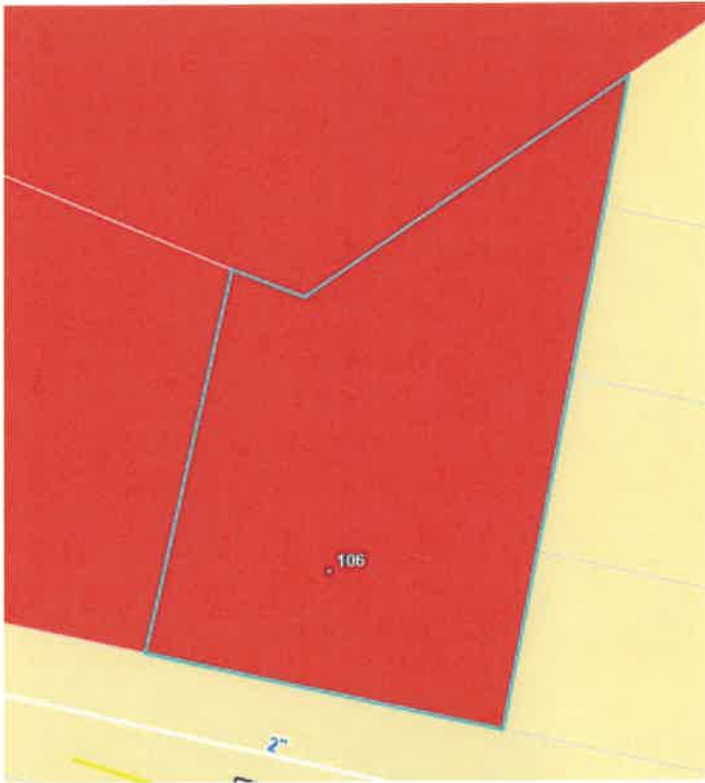

Erwin Board of Commissioners

REQUEST FOR CONSIDERATION

To: The Honorable Mayor and Board of Commissioners

From: Snow Bowden, Town Manager

Date: February 26, 2024

Subject: Golf Course R-15 Permitted Use Text Amendment

Town Staff has prepared a text amendment to our Town Code. The proposed text amendment would add golf courses as a permitted use in our R-15 Zoning District. The proposed text amendment also includes a definition of a golf course. The Planning Board has recommended this text amendment for approval.

Proposed permitted uses to be added to R-15:

- Golf courses

Proposed definition of a golf course:

- An area of land laid out for golf with a series of 9 to 18 holes varying from 100 to 600 yards with each including a tee, fairway, putting greens, bunkers and that may contain clubhouses, areas for refreshment, or golf equipment sales.

MINUTES CONTINUED FROM FEBRUARY 26, 2024

R.O.W Maintenance Text Amendment

Town Planner Dylan Eure informed the Board that this text amendment would be making a requirement for homeowners in the Town of Erwin to maintain their right of way to the edge of the street.

The consensus of the Board was to move forward with holding a Public Hearing at our Regularly Scheduled Meeting in March.

Close Bayles Street Extension

Town Manager Snow Bowden stated that the Town Board approved a Resolution Declaring Intent at our February Board Meeting to close an undeveloped section of Bayles Street. A public hearing was declared for our regularly scheduled board meeting in March. Once the public hearing is held, a certified copy of the order must be filed with the Harnett County Register of Deeds. Anyone who disagreed with the order had 30 days after its adoption to appeal the order to the General Court of Justice. The easement will be split between the two property owners and return the property back to private property.

Upcoming Events

Town Manager Snow Bowden made the Board aware of two upcoming events to consider attending. The North Carolina League of Municipalities State and Local Dinner will be held on Wednesday, March 27th in Pinehurst, NC. Senator Burgin and Representative Penny will both be attending this dinner. Mid-Carolina Council of Governments Annual Regional Dinner will be held on Thursday, March 28th in Salemburg, NC. He asked that anyone planning to attend, to please let Town Clerk Lauren Evans know by Friday, March 8th.

CLOSED SESSION

Commissioner McKoy made a motion to go into Closed Session Pursuant to General Statute 143-318.11(a) (6) for the Purpose of Discussing Personnel and Pursuant to General Statute 143-318.aa(a) (3) for the Purpose of Preserving the Attorney Client Privilege at 7:16 PM and was seconded by Commissioner Nelson. **The Board voted unanimously.**

RECONVENED

Commissioner McKoy made a motion to go back to regular session at 7:51 PM. and was seconded by Commissioner Nelson. **The Board voted unanimously.**

Erwin Board of Commissioners

REQUEST FOR CONSIDERATION

To: The Honorable Mayor and Board of Commissioners

From: Snow Bowden, Town Manager

Date: February 26, 2024

Subject: R.O.W Maintenance Text Amendment

Town Staff has prepared a text amendment to our Town Code. The proposed text amendment would add language to a section of our Town Code in regards to weeds, hedges, tall grass and other vegetation. It clears up who is responsible for maintaining the right-of-way.

Current language:

(7) Hedges or dense, thorny shrubs extending into the public right-of-way

Proposed language:

(7) Hedges, dense thorny shrubs, weeds, grass, brush, poisonous vegetation or any other over grown / dead vegetation as defined in items (1),(3), and (4) of Section 12-92. of this article extending into the public right-of-way to the edge of the street

Current Un-amended Diction:

Weeds and nuisance vegetation under this article shall include the following which may occur on any lot within the corporate limits of the town:

- (1) Weeds or vegetation allowed to grow to a height greater than 12 inches on the average, or any accumulation of dead weeds, grass or brush, on any lot regardless of size and whether developed or undeveloped, or on any occupied or unoccupied lot or land less than one acre in area excluding wooded areas, that may provide safe harborage for rats, mice, snakes, and other vermin;
- (2) Any dead, diseased, infested or dying tree or shrub on any property so near to a street, public right-of-way or a public utility easement as to constitute a danger to street trees, public utility services' streets, sidewalks, vehicle travel, persons or property other than that of the owner of the tree;
- (3)Vegetation which creates a nuisance by its existence (i.e., poison ivy, kudzu);
- (4)Dead or dying trees or plants which may cause a hazardous situation if they fall;
- (5)Vines or climbing plants growing into or over any street tree, fire hydrant, pole, utility wire or electrolier;
- (6)Branches, roots, trees, shrubs or foliage that interfere with visibility on, illumination of, or the free, safe, or undamaged use of, or access to or along any portion of any public street or sidewalk;
- (7)Hedges or dense, thorny shrubs extending into the public right-of-way;
- (8) Branches of trees that extend within eight vertical feet from any portion of a public sidewalk or within 14 vertical feet from any portion of a public street.

Proposed Amended Diction:

Weeds and nuisance vegetation under this article shall include the following which may occur on any lot within the corporate limits of the town:

- (1) Weeds or vegetation allowed to grow to a height greater than 12 inches on the average, or any accumulation of dead weeds, grass or brush, on any lot regardless of size and whether developed or undeveloped, or on any occupied or unoccupied lot or land less than one acre in area excluding wooded areas, that may provide safe harborage for rats, mice, snakes, and other vermin;

(2) Any dead, diseased, infested or dying tree or shrub on any property so near to a street, public right-of-way or a public utility easement as to constitute a danger to street trees, public utility services' streets, sidewalks, vehicle travel, persons or property other than that of the owner of the tree;

(3)Vegetation which creates a nuisance by its existence (i.e., poison ivy, kudzu);

(4)Dead or dying trees or plants which may cause a hazardous situation if they fall;

(5)Vines or climbing plants growing into or over any street tree, fire hydrant, pole, utility wire or electrolier;

(6)Branches, roots, trees, shrubs or foliage that interfere with visibility on, illumination of, or the free, safe, or undamaged use of, or access to or along any portion of any public street or sidewalk;

(7) Hedges, dense thorny shrubs, weeds, grass, brush, poisonous vegetation or any other over grown / dead vegetation as defined in items (1),(3), and (4) of Section 12-92. of this article extending into the public right-of-way to the edge of the street;

(8) Branches of trees that extend within eight vertical feet from any portion of a public sidewalk or within 14 vertical feet from any portion of a public street

Erwin Board of Commissioners

REQUEST FOR CONSIDERATION

To: The Honorable Mayor and Board of Commissioners

From: Snow Bowden, Town Manager

Date: February 26, 2024

Subject: Bayles Street Extension Close

This section of Bayles Street was never developed and extends to the parcel that the Wal-Mart is located on currently. As we all know the Wal-Mart is in the City of Dunn corporate limits. There would never be a need to develop this section of the undeveloped road. On May 3, 2023 there was a subdivision recorded that subdivided the two existing parcels at 608 and 610 Wondertown Drive. Before this subdivision was recorded there were some potential ingress/egress concerns Town Staff had. Town Staff wishes to close this easement and return the portion of the land to each property owner so it will be considered private property. Once it returns to private property we believe that we can better monitor the area. Any problem traffic we get from Wal-Mart would be considered trespassing since they would be on private property.

Attachments:

- NCGS 136-96
- Harnett County GIS image
- Intent to Close Resolution Adopted February 1, 2024

§ 160A-299. Procedure for permanently closing streets and alleys.

(a) When a city proposes to permanently close any street or public alley, the council shall first adopt a resolution declaring its intent to close the street or alley and calling a public hearing on the question. The resolution shall be published once a week for four successive weeks prior to the hearing, a copy thereof shall be sent by registered or certified mail to all owners of property adjoining the street or alley as shown on the county tax records, and a notice of the closing and public hearing shall be prominently posted in at least two places along the street or alley. If the street or alley is under the authority and control of the Department of Transportation, a copy of the resolution shall be mailed to the Department of Transportation. At the hearing, any person may be heard on the question of whether or not the closing would be detrimental to the public interest, or the property rights of any individual. If it appears to the satisfaction of the council after the hearing that closing the street or alley is not contrary to the public interest, and that no individual owning property in the vicinity of the street or alley or in the subdivision in which it is located would thereby be deprived of reasonable means of ingress and egress to his property, the council may adopt an order closing the street or alley. A certified copy of the order (or judgment of the court) shall be filed in the office of the register of deeds of the county in which the street, or any portion thereof, is located.

(b) Any person aggrieved by the closing of any street or alley including the Department of Transportation if the street or alley is under its authority and control, may appeal the council's order to the General Court of Justice within 30 days after its adoption. In appeals of streets closed under this section, all facts and issues shall be heard and decided by a judge sitting without a jury. In addition to determining whether procedural requirements were complied with, the court shall determine whether, on the record as presented to the city council, the council's decision to close the street was in accordance with the statutory standards of subsection (a) of this section and any other applicable requirements of local law or ordinance.

No cause of action or defense founded upon the invalidity of any proceedings taken in closing any street or alley may be asserted, nor shall the validity of the order be open to question in any court upon any ground whatever, except in an action or proceeding begun within 30 days after the order is adopted. The failure to send notice by registered or certified mail shall not invalidate any ordinance adopted prior to January 1, 1989.

(c) Upon the closing of a street or alley in accordance with this section, subject to the provisions of subsection (f) of this section, all right, title, and interest in the right-of-way shall be conclusively presumed to be vested in those persons owning lots or parcels of land adjacent to the street or alley, and the title of such adjoining landowners, for the width of the abutting land owned by them, shall extend to the centerline of the street or alley.

The provisions of this subsection regarding division of right-of-way in street or alley closings may be altered as to a particular street or alley closing by the assent of all property owners taking title to a closed street or alley by the filing of a plat which shows the street or alley closing and the portion of the closed street or alley to be taken by each such owner. The plat shall be signed by each property owner who, under this section, has an ownership right in the closed street or alley.

(d) This section shall apply to any street or public alley within a city or its extraterritorial jurisdiction that has been irrevocably dedicated to the public, without regard to whether it has actually been opened. This section also applies to unopened streets or public alleys that are shown on plats but that have not been accepted or maintained by the city, provided that this section shall not abrogate the rights of a dedicator, or those claiming under a dedicator, pursuant to G.S. 136-96.

(e) No street or alley under the control of the Department of Transportation may be closed unless the Department of Transportation consents thereto.

(f) A city may reserve a right, title, and interest in any improvements or easements within a street closed pursuant to this section. An easement under this subsection shall include utility, drainage, pedestrian, landscaping, conservation, or other easements considered by the city to be in the public interest. The reservation of an easement under this subsection shall be stated in the order of closing. The reservation also extends to utility improvements or easements owned by private utilities which at the time of the street closing have a utility agreement or franchise with the city.

(g) The city may retain utility easements, both public and private, in cases of streets withdrawn under G.S. 136-96. To retain such easements, the city council shall, after public hearing, approve a "declaration of retention of utility easements" specifically describing such easements. Notice by certified or registered mail shall be provided to the party withdrawing the street from dedication under G.S. 136-96 at least five days prior to the hearing. The declaration must be passed prior to filing of any plat or map or declaration of withdrawal with the register of deeds. Any property owner filing such plats, maps, or declarations shall include the city declaration with the declaration of withdrawal and shall show the utilities retained on any map or plat showing the withdrawal. (1971, c. 698, s. 1; 1973, c. 426, s. 47; c. 507, s. 5; 1977, c. 464, s. 34, 1981, c. 401; c. 402, ss. 1, 2; 1989, c. 254; 1993, c. 149, s. 1; 2015-103, s. 1.)

NOT FOR LEGAL USE



Harnett County GIS

0 40 80 160 Feet

- County Boundary
- City Limits
- Address Numbers
- Road Centerlines
- Parcels

Ronald & Andrea Delease
612 Wondertown Dr
Erwin, NC 28339

Tila Karpen & Shloma Landau
610 Wondertown Dr
Erwin, NC 28339

Sybil W. Pope
2275 Big Landing Dr
Little River, SC 29566



TOWN OF ERWIN

P.O. Box 459 · Erwin, NC 28339
Ph: 910-897-5140 · Fax: 910-897-5543
www.erwin-nc.org

Mayor
Randy L. Baker
Mayor Pro Tem
Ricky W. Blackmon
Commissioners
Alvester L. McKoy
Timothy D. Marbell
Charles L. Byrd
David L. Nelson
William R. Turnage

TOWN OF ERWIN RESOLUTION DECLARING INTENT TO CLOSE UNDEVELOPED SECTION OF BAYLES STREET 2023-2024—002

WHEREAS, the Erwin Town Board is authorized by G.S. 160A-299 to permanently close unopened municipal street rights-of-way with its jurisdiction, if it is determined that said street closure is not found to be contrary to the public interest and will not deprive any property owner in the vicinity of the street closure reasonable means of ingress and egress to his/her property; and,

WHEREAS, a request has been made of the Erwin Town Board to consider permanently closing the undeveloped section of Bayles Street, that extends from to the parcel that the Wal-Mart is located on currently.

NOW THEREFORE BE IT RESOLVED, that it is the intent of the Erwin Town Board to permanently close undeveloped section of Bayles Street as previously described, and it hereby establishes a public hearing to be held on March 7, 2024 at 7:00 p.m. in the Erwin Municipal Building Board Room; and,

BE IT FURTHER RESOLVED, that the purpose of the public hearing will be to determine if undeveloped section of Bayles Street being requested for permanent closure would be detrimental to the public interest, or to the property rights of any individual.

DULY ADOPTED, this the 1st day of February, 2024.

Randy Baker
Mayor

ATTEST:

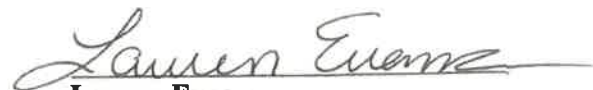
Lauren Evans
Town Clerk

Erwin Board of Commissioners

REQUEST FOR CONSIDERATION

To: The Honorable Mayor and Board of Commissioners

From: Snow Bowden, Town Manager

Date: February 26, 2024

Subject: Upcoming Events

We have two upcoming events that we are encouraging you to consider attending. You do not have to attend if you do not want to. If you would like to attend please let us know so we can get you registered for the event.

- North Carolina League of Municipalities State and Local Dinner
 - Wednesday, March 27th from 5:15PM till 8:15PM in Pinehurst, NC
- Mid-Carolina Council of Governments Annual Regional Dinner
 - Thursday, March 28th (day before Good Friday FYI) at 5:15PM in Salemburg, NC

I plan on attending both of these events.

MINUTES CONTINUED FROM FEBRUARY 26, 2024

GOVERNING COMMENTS

Commissioner Nelson stated that he was glad to see that the hole in his road was patched.

Mayor Baker thanked Town Staff for all of their hard work and thanked the Town Board Members for taking time out of their busy schedules to be at the Workshop.

ADJOURNMENT

Commissioner Nelson made a motion to adjourn at 7:52 P.M. and was seconded by Commissioner Turnage. **The Board voted unanimously.**

**MINUTES RECORDED AND TYPED BY
LAUREN EVANS TOWN CLERK**



Randy Baker

Mayor

ATTEST:



Lauren Evans NCCMC

Town Clerk